

SECTION - 3

ENCLOSURES TO THE SPECIFICATION

- 1 PGCIL Technical Specification, Section: Civil Works (C/ENGG/SPEC/CIVIL/ Rev No.: 07)**
- 2 PGCIL Standard Field Quality Plan for Switchyard Civil Works**
- 3 PGCIL Drawings (As per attached "List of Drawings")**

SECTION: CIVIL

1.0 GENERAL

The intent of this technical specification covers the following:

Construction of all civil works at sub-station is covered in the scope of contract as per drawings supplied by Owner.

All civil works shall be carried out as per design/drawings standardised by the Owner and these specification provided by the Owner. All standard drawings are enclosed with the tender documents. In case any item is not covered under specification then the same shall be carried out as per CPWD specification and applicable Standards and Codes. Any item for which specification is not provided herein and is not covered under CPWD specification shall be executed as per manufacturer guidelines. All materials shall be of best quality conforming to relevant Indian Standards and Codes. In case of any conflict between Standards/ Code and Technical Specification, the provisions of Technical Specification shall prevail.

The Contractor shall furnish all labour, tools, equipment, materials, temporary works, constructional plant and machinery, fuel supply, transportation and all other incidental items not shown or specified but as may be required for complete performance of the Works in accordance with drawings, specifications and direction of Owner.

All materials including cement, reinforcement steel and structural steel etc. shall be arranged by the Contractor. All testing required shall be arranged by the Contractor at his own cost. The contractor shall execute the work as per the Field Quality Plan (FQP) attached with this document.

The bidder shall fully appraise himself of the prevailing conditions at the proposed site. Climatic conditions including monsoon patterns, local conditions and site specific parameters and shall include for all such conditions and contingent measures in the bid, including those which may not have been specifically brought out in the specifications.

2.0 Drawings

Standard drawings have been developed by the Owner, as mentioned below, and are enclosed with the tender documents. The drawings enclosed with the tender are good for construction. However, after the award, 4 sets of these drawings, with a released for construction stamp, shall be issued by the Owner to the Contractor matching with the requirement at Site or the contractor may be advised to follow tender drawings. The Contractor shall execute the work at Site as per these

drawings only.

Drawings that have been mentioned to be issued by the Owner to the Contractor during detailed Engineering shall be made available to the Contractor as per the agreed work schedule finalised after award. Also, further details required, if any, to complete the work in totality, shall be made available to the Contractor as per the agreed work schedule finalised after award.

2.1 Control room building

All construction drawings are enclosed with the tender documents.

2.2 Fire fighting pump house building and fire water tank

All construction drawings are enclosed with the tender documents.

2.3 Tower & equipment foundations

All construction drawings for towers and equipments foundations are enclosed with the tender documents.

Drawings for any non-standard tower or equipment foundation, if required, shall be designed by the Owner and made available to the Contractor during detailed Engineering. Foundations for any miscellaneous requirements like electric poles, marshalling box, control cubicles, etc. shall be engineered by the Contractor and the design and drawings shall be submitted for owner's approval.

Drawings for transformer, reactor foundations and fire wall are not enclosed and shall be made available to the contractor by the owner during detailed engineering.

In case the site conditions warrant any special type of foundations to be used, the same shall be designed and issued by the owner to the contractor during detailed engineering.

2.4 Township Works

The Construction drawings of all the residential and non-residential buildings i.e. B-1, B-2, B-3, C & D type Quarters, transit camp, recreation centre, covered parking are enclosed herewith with the tender documents. Layout of the township shall be issued to the Contractor by the site.

2.5 Roads and rail cum Road

The construction drawings showing section detail for road as well as rail cum road is enclosed with the tender documents.

2.6 Drains

The construction drawing for the *section of* drain is enclosed with the tender documents. The contractor shall develop an overall drainage layout for the new sub-station/ extension of substation during detailed engineering. The type of drains used shall be of the sections standardized and indicated in the drawings enclosed with the tender documents.

2.7 Under Ground Water Tank

The construction drawing for the under ground water tank and pump house for water supply to township have been provided in the tender document. The scope also includes supplying and erection of 2 numbers ISI marked centrifugal water pump (Monoblock) at 415 Voltage 3 phase 50 cycle/per second of 7.5 HP along with all necessary accessories.

2.8 External Sewage System of Township

The drawing for the Sewage system consisting of glazed stoneware pipes Grade-A with all round cement grade 1:5:10 including manholes, road crossing, gali trap connections etc for connecting each fittings with the septic tank shall be developed by the Contractor and submitted to Engineer-in-Charge for approval before execution. Manholes of suitable size as per CPWD standard design and depth shall be provided at all turning points and junction with spacing between 2 manholes not exceeding 30m. Heavy duty covers shall be provided for the manholes in case it comes on the road.

2.9 Chain link fencing and gate

The construction drawings are enclosed with the tender documents.

2.10 Rain water harvesting

The construction drawings are enclosed with the tender documents.

2.11 External water supply from bore-well to fire water tank

The drawing for the water supply from bore-well to fire water tank shall be developed by the contractor and submitted to owner for approval. Water supply will be made available to the Contractor from a bore-well by the Owner at any one location within the sub-station. 80 mm dia GI pipe shall be provided by the Contractor from the bore-well to the fire water tank. From this a 25 mm dia tap off shall be connected by the Contractor to the roof water tank provided for the control room building.

2.12 Septic tank and soak pit

The construction drawings are enclosed with the tender documents.

2.12 Stone spreading and antiweed treatment

The layout of the area where anti-weed treatment and stone spreading is to be provided shall be made available to the contractor during detailed engineering.

3.0 SITE PREPARATION:

Levelled/sloped site shall be handed over to the contractor. The finished ground level (FGL) shall be the finished formation level furnished by the owner. The layout and levels of all structure etc shall be made by the Contractor at his own cost from the general grids of the plot and benchmarks set by the Contractor and approved by the Owner. The Contractor shall provide all assistance in instruments, materials and personnel to the Owner for checking the detailed layout and shall be solely responsible for the correctness of the layout and levels.

3.1 SCOPE

This clause covers the execution of the work for site preparation, such as clearing of the site, the supply and compaction of fill material, excavation and compaction of backfill for foundation, road construction, drainage, trenches and final topping by stone (broken hard stone).

3.2 GENERAL

- 1) Material unsuitable for founding of foundations shall be removed and replaced by suitable fill material and to be approved by the Owner.
- 2) Backfill material around foundations or other works shall be suitable for the purpose for which it is used and compacted to the density described under Compaction. Excavated material not suitable or not required for backfill, shall be disposed off in area's as directed

by Owner up to a maximum lead of 2 km.

3.3 EXCAVATION AND BACKFILL

1. Excavation and backfill for foundations shall be in accordance with the relevant code.
2. Whenever water table is met during the excavation, it shall be dewatered and water table shall be maintained below the bottom of the excavation level during excavation, concreting and backfilling.
3. Embankments adjacent to abutments, culverts, retaining walls and similar structures shall be constructed by compacting the material in successive uniform horizontal layers not exceeding 20 cm in thickness. (of loose material before compaction). Each layer shall be compacted as required by means of mechanical tampers approved by the Owner. Rocks larger than 10 cm in any direction shall not be placed in embankment adjacent to structures.
4. Earth embankments of roadways and site areas adjacent to buildings shall be placed in successive uniform horizontal layers not exceeding 20 cm in thickness in loose stage measurement and compacted to the full width specified. The upper surface of the embankment shall be shaped so as to provide complete drainage of surface water at all times.

3.4 COMPACTION

1. The density to which fill materials shall be compacted shall be as per relevant IS and as per direction of Owner. All compacted sand filling shall be confined as far as practicable. Backfilled earth shall be compacted to minimum 95% of the Standard Proctor's density at OMC. The subgrade for the roads and embankment filling shall be compacted to minimum 95% of the Standard Proctor's density at OMC. Cohesion less material subgrade shall be compacted to 70% relative density (minimum).
2. At all times unfinished construction shall have adequate drainage. Upon completion of the road's surface course, adjacent shoulders shall be given a final shaping, true alignment and grade.
3. Each layer of earth embankment when compacted shall be as close to optimum moisture content as practicable. Embankment material which does not contain sufficient moisture to obtain proper compaction shall be wetted. If the material contains any excess moisture, then it shall be allowed to dry before rolling. The rolling

shall begin at the edges overlapping half the width of the roller each time and progress to the center of the road or towards the building as applicable. Rolling will also be required on rockfills. No compaction shall be carried out in rainy weather.

3.5 REQUIREMENT FOR FILL MATERIAL UNDER FOUNDATION

The thickness of fill material under the foundations shall be such that the maximum pressure from the footing, transferred through the fill material and distributed onto the original undisturbed soil will not exceed the allowable soil bearing pressure of the original undisturbed soil. For expansive soils the fill materials and other protections etc. to be used under the foundation is to be got approved by the Owner.

4.0 ANTIWEED TREATMENT & STONE SPREADING

4.1 SCOPE OF WORK

The Contractor shall furnish all labour, equipment and materials required for complete performance of the work in accordance with the drawings, specification and direction of the Owner.

Stone spreading along with cement concrete layer shall be done in the areas of the switchyard under present scope of work. However the stone spreading along with cement concrete layer in future areas within fenced area shall also be provided in case step potential without stone layer is not well within safe limits.

4.2 GENERAL REQUIREMENT

The material required for site surfacing/stone filling shall be free from all types of organic materials and shall be of standard quality, and as approved by the Owner.

4.2.1 The material to be used for stone filling/site surfacing shall be uncrushed/crushed/broken stone of 40mm nominal size (ungraded single size) conforming to Table 2 of IS:383 – 1970. Hardness, flakiness shall be as required for wearing courses are given below :

(a) Sieve Analysis limits (Gradation)
(IS : 383 – Table – 2)

Sieve Size	% passing by weight
63mm	100
40mm	85-100

20mm 0-20

10mm 0-5

“One Test” shall be conducted for every 500 cu.m.

(b) Hardness

Abrasion value (IS:2386 Part-IV) – not more than 40%

Impact value (IS:2386 Part-IV) – not more than 30% and frequency shall be one test per 500 cu.m. with a minimum of one test per source.

(c) Flakiness Index

One test shall be conducted per 500 cu.m. of aggregate as per IS:2386 Part – I and maximum value is 25%.

4.2.2 After all the structures/equipments are erected, antiweed treatment shall be applied in the switchyard where ever stone spreading along with cement concrete is to be done and the area shall be thoroughly de-weeded including removal of roots. The recommendation of local agriculture or horticulture department may be sought where ever feasible while choosing the type of chemical to be used. The antiweed chemical shall be procured from reputed manufacturers. The doses and application of chemical shall be strictly done as per manufacturer’s recommendation. Nevertheless the effectiveness of the chemical shall be demonstrated by the contractor in a test area of 10MX10M (appx) and shall be sprinkled with water at least once in the afternoon everyday after forty eight hours of application of chemical. The treated area shall be monitored over a period of two to three weeks for any growth of weeds by the Engineer – in- charge. The final approval shall be given by Engineer – in –charge based on the results.

4.2.3 Engineer-in-charge shall decide final formation level so as to ensure that the site appears uniform devoid of undulations. The final formation level shall however be very close to the formation level indicated in the approved drawing.

4.2.4 After antiweed treatment is complete, the surface of the switchyard area shall be maintained, rolled/compacted to the lines and grades as decided by Engineer-in-charge. The sub grade shall be consolidated by using half ton roller with suitable water sprinkling arrangement to form a smooth and compact surface. The roller shall run over the sub grade till the soil is evenly and densely consolidated and behaves as an elastic mass.

4.2.5 In areas that are considered by the Engineer-in-Charge to be too congested with foundations and structures for proper rolling of the site surfacing material by normal rolling equipments, the material shall be compacted by hand, if

necessary. Due care shall be exercised so as not to damage any foundation structures or equipment during rolling compaction.

- 4.2.6 The sub grade shall be in moist condition at the time the cement concrete is placed. If necessary, it should be saturated with water for not less than 6 hours but not exceeding 20 hours before placing of cement concrete. If it becomes dry prior to the actual placing of cement concrete, it shall be sprinkled with water and it shall be ensured that no pools of water or soft patches are formed on the surface.
- 4.2.7 Over the prepared sub grade, 75mm thick base layer of cement concrete in 1:5:10 (1 cement :5 fine/coarse sand : 10 burnt brick aggregate. shall be provided in the area excluding roads, drains, cable trenches as per detailed engineering drawing. For easy drainage of water, the slope of 1:1000 is to be provided from the ridge to the nearest drain. The ridge shall be suitably located at the centre of the area between the nearest drains. The above slope shall be provided at the top of base layer of cement concrete in 1:5:10. A layer of cement slurry of mix 1:6 (1 cement : 6 fine sand) shall be laid uniformly over cement concrete layer. The cement consumption for cement slurry shall not be less than 150 kg. Per 100 sq.m.
- 4.2.8 A final layer of 100mm thickness of uncrushed/crushed/broken stone of 40 nominal size (ungraded size) shall be spread uniformly over cement concrete layer after curing is complete.

5.0 RAINWATER HARVESTING:

- 5.1 In addition to drainage of rainwater, the contractor shall make arrangement for rainwater harvesting also.
- 5.2 Rainwater harvesting shall be done by providing two numbers recharge structures with bore wells. The recharge structures shall be suitably located within the sub-station. Branch drains from the main drain carrying rainwater from entire switchyard shall be connected to the recharge structures.
- 5.3 The internal diameter of recharge shafts shall be 4.5 meter with 230mm thick lining of brick work upto a depth of 2.0 meter from ground level and 345mm thick brickwork below 2.0 meter depth. The brickwork shall be constructed with cement mortar 1:6 (1 cement : 6 coarse sand). The overall depth of shaft shall be 5.0 meter below invert level of drain. The shaft shall be covered with RCC slab for a live load of 300 kg. per sq.m. Two openings of size 0.7 x 0.7 meter shall be provided in the RCC cover slab as shown in the drawing. An iron cover made of 5mm thick chequered plate with hinges shall be provided on the openings. Galvanized M.S. rungs of 20mm diameter at spacing of 300 mm shall be provided in the wall of shaft below the opening in the RCC slab to facilitate cleaning of shaft.

- 5.4 A 300 mm diameter bore well shall be drilled in the centre of the shaft. The depth of bore well shall be 5.0 meter more than the depth of sub soil water.
- 5.5 A 100 mm dia medium duty MS pipe conforming to IS 1161 shall be lowered in the bore well keeping bail plug towards bottom of bore well. The pipe shall have 1.58mm holes for 4.0 meter length starting from 1.0 meter from bottom of bore well. Holes of 3.0mm dia shall be provided for a length of 2.0 meter starting from the bottom level of coarse sand and down wards. The overall length of pipe shall be equal to total depth of bore well plus depth of shaft.
- 5.6 Gravel of size 3mm to 6mm shall be filled around 100 dia MS pipe in the borewell. The shaft shall be filled with 500 mm thick layers each from the bottom of shaft with boulders of size 50mm to 150mm, gravel of size 5mm to 10mm, coarse sand having particle size 1.5mm to 2.0mm and boulders of size not less than 200mm respectively.

A drawing showing details of recharge structure for rainwater harvesting is enclosed.

6.0 ROADS AND CULVERTS

- 6.1 All the roads in the scope of contract shall be of concrete road.
- 6.2 There would be two types of Roads. The wider road shall be 5.5m wide and the other road shall be 3.75m wide.

The road outside the switchyard fenced area shall have shoulder of 1.75m in case of 5.5m wide road and 1.3 m in case of 3.75m wide road with kerb stone at the two side ends of the road. Interlocking tiles shall be laid on this shoulder. Kerb stone with channel are to be provided at both the side of the roads. The kerb stone on both side of the roads shall be painted yellow and black alternatively.

In case of switchyard road the shoulder would be compacted earth 600mm wide on the sides of both types of road.

- 6.3 Layout of the roads shall be as shown in the General Arrangement drawing for the substation issued along with the tender documents. Adequate turning space for vehicles shall be provided and bend radii shall be set accordingly. Road to the Autotransformer/Reactor shall be as short and straight as possible.
- 6.4 The road shall have 100mm thick RCC (1:1.5:3 nominal mix with reinforcement of 8mm dia. 300 C/C bothways) on the top. Below it 100mm thick PCC (1:4:8) shall be provided. 300mm thick water bound macadam (WBM) in three equal layers of 100mm each at the bottom.

PCC and WBM shall extend upto the shoulder width on both sides of the road outside switchyard area as per the drawing. In case of road within the switchyard PCC and WBM shall placed only upto the width of the road. Polythene sheet of 125 microns shall be placed between the RCC and PCC slab. Expansion joint (12mm thick) shall be provided at every 8.0 m. In addition, in case of 5.5 m wide road, expansion joint shall also be provided longitudinally at the center. 100mm dia RCC hume pipe (NP-3) shall be provided at every 100m interval across the length of the road for cable crossing.

The concrete shall be laid and finished with screed board, vibration, vacuum dewatering process and finishing by floating brooming with wire brush etc.

- 6.5 The details are furnished in the drawing enclosed with tender document.
- 6.6 The shoulder of the road in case of extension shall match with the shoulder of the existing road.

7.0 FOUNDATION /RCC CONSTRUCTION

7.1 GENERAL

1. Work covered under this Clause of the Specification comprises the construction of foundations and other RCC constructions for switchyard structures, equipment supports, trenches, drains, jacking pad, pulling block, control cubicles, bus supports, Autotransformer/Reactors, marshalling kiosks, auxiliary equipments & systems buildings, tanks or for any other equipment or service and any other foundation required to complete the work. This clause is as well applicable to the other RCC constructions.
2. Concrete shall conform to the requirements mentioned in IS:456 and all the tests shall be conducted as per relevant Indian Standard Codes as mentioned in Standard field quality plan appended with the specification. However, a minimum grade of M20 concrete (1: 1.5: 3 nominal volumetric mix) shall be used for all structural/load bearing members
3. If the site is sloping, the foundation height will be adjusted to maintain the exact level of the top of structures to compensate such slopes.

The switchyard foundation's plinths and building plinths shall be minimum 300mm and 500mm above finished ground level respectively.

5. Minimum 75mm thick lean concrete (1:4:8) shall be provided below all

underground structures, foundations, trenches etc. to provide a base for construction.

6. Concrete made with Portland slag cement shall be carefully cured and special importance shall be given during the placing of concrete and removal of shuttering.
7. The design and detailing of foundations shall be done based on the approved soil data and sub-soil conditions as well as for all possible critical loads and the combinations thereof. The Spread footings foundation or pile foundation as may be required based on soil/sub-soil conditions and superimposed loads shall be provided.
8. If pile foundations are adopted, the same shall be cast-in-situ bored or pre-cast or under reamed type as per relevant parts of IS 2911. Only RCC piles shall be provided. Necessary initial load test shall be carried out by the Contractor at their cost to establish the piles design capacity. Only after the design capacity of piles have been established, the Contractor shall take up the job of piling. Routine tests for the piles shall also be conducted as per IS-2911. All the testing work shall be planned in such a way that these shall not cause any delay in project completion.

7.2 DESIGN

The following clauses shall be applicable only for the foundation / structure which the contractor may have to design as mentioned at Clause 2.3.

1. All foundation shall be of reinforced cement concrete. The design and construction of RCC structures shall be carried out as per IS:456 and minimum grade of concrete shall be M-20. This M20 shall correspond to nominal volumetric mix of 1:1.5:3.
2. Limit state method of design shall be adopted unless specified otherwise in the specification.
3. For detailing of reinforcement IS: 2502 and SP:34 shall be followed. Cold twisted deformed bars ($F_y=415$ N/mm²) conforming to IS: 1786, or equivalent TMT bars of equivalent or higher grade as per CPWD specifications shall be used as reinforcement. However, in specific areas, mild steel (Grade I) conforming to IS: 432 can also be used. Two layers of reinforcement (on inner and outer face) shall be provided for wall & slab sections having thickness of 150 mm and above. Clear cover to reinforcement shall be as per IS:456 (latest).
4. RCC water retaining structures like storage tanks, etc. shall be

designed as uncracked section in accordance with IS:3370 (Part I to IV) by working stress method. However, water channels shall be designed as cracked section with limited steel stresses as per IS:3370 (Part I to IV) by working stress method.

5. The procedure used for the design of the foundations shall be the most critical loading combination of the steel structure and or equipment and/or superstructure and other conditions which produces the maximum stresses in the foundation or the foundation component and as per the relevant IS Codes of foundation design. Detailed design calculations shall be submitted by the bidder showing complete details of piles/pile groups proposed to be used.
6. Design shall consider any sub-soil water pressure that may be encountered following relevant standard strictly.
7. Necessary protection to the foundation work, if required shall be provided to take care of any special requirements for aggressive alkaline soil, black cotton soil or any other type of soil which is detrimental/harmful to the concrete foundations.
8. RCC columns shall be provided with rigid connection at the base.
9. All sub-structures shall be checked for sliding and overturning stability during both construction and operating conditions for various combinations of loads. Factors of safety for these cases shall be taken as mentioned in relevant IS Codes or as stipulated elsewhere in the Specifications. For checking against overturning, weight of soil vertically above footing shall be taken and inverted frustum of pyramid of earth on the foundation should not be considered.
10. Earth pressure for all underground structures shall be calculated using co-efficient of earth pressure at rest, co-efficient of active or passive earth pressure (whichever is applicable). However, for the design of substructures of any underground enclosures, earth pressure at rest shall be considered.
11. In addition to earth pressure and ground water pressure etc., a surcharge load of $2T/Sq.m$ shall also be considered for the design of all underground structures including channels, sumps, tanks, trenches, substructure of any underground hollow enclosure etc., for the vehicular traffic in the vicinity of the structure.
12. Following conditions shall be considered for the design of water tank in pumps house, channels, sumps, trenches and other underground structures:

- a) Full water pressure from inside and no earth pressure & ground water pressure & surcharge pressure from outside (application only to structures which are liable to be filled up with water or any other liquid).
 - b) Full earth pressure, surcharge pressure and ground water pressure from outside and no water pressure from inside.
 - c) Design shall also be checked against buoyancy due to the ground water during construction and maintenance stages. Minimum factor of safety of 1.5 against buoyancy shall be ensured ignoring the superimposed loadings.
13. Base slab of any underground enclosure shall also be designed for empty condition during construction and maintenance stages with maximum ground water table (GWT). Minimum factor of safety of 1.5 against buoyancy shall be ensured ignoring the super-imposed loadings.
14. Base slab of any underground enclosure like water storage tank shall also be designed for the condition of different combination of pump sumps being empty during maintenance stages with maximum GWT. Intermediate dividing piers of such enclosures shall be designed considering water in one pump sump only and the other pumps sump being empty for maintenance.
15. The foundations shall be proportioned so that the estimated total and differential movements of the foundations are not greater than the movements that the structure or equipment is designed to accommodate.
16. The foundations of transformer/reactor and circuit breaker shall be of block type foundation. Minimum reinforcement shall be governed by IS: 2974 and IS:456.
17. The tower and equipment foundations shall be checked for a partial factor of safety of 2.2 for normal condition and 1.65 for short circuit condition.
18. The Contractor shall provide a RCC Rail cum road system integrated with the Autotransformer / Reactor foundation to enable installation and the replacement of any failed unit . The transfer track system shall be suitable to permit the movement of any failed unit fully assembled (including OLTC, bushings) with oil. This system shall enable the removal of any failed unit from its foundation to the nearest road. If trench/drain crossings are required then suitable R.C.C. culverts shall be provided in accordance with I.R.C. standard / relevant IS.

The Contractor shall provide a pylon support system for supporting the fire fighting system.

Each Autotransformer/Reactor including oil conservator tank and cooler banks etc. shall be placed in a self-sufficient pit surrounded by retaining walls (Pit walls). The clear distance of the retaining wall of the pit from the Autotransformer/Reactor shall be 20% of the Autotransformer/Reactor height or 0.8m whichever is more. The oil collection pit thus formed shall have a void volume equal to 200% volume of total oil in the Autotransformer/Reactor. The minimum height of the retaining walls shall be 15 cm above the finished level of the ground to avoid outside water pouring inside the pit. The bottom of the pit shall have an uniform slope towards the sump pit. While designing the oil collection pit, the movement of the autotransformer / reactor must be taken into account.

The grating shall be made of MS flat of size 40mmx 5mm placed at 30mm centre to centre and 25mmx5mm MS flat at an spacing of 150mm at right angle to each other. Maximum length of grating shall be 2000mm and width shall not be more than 500mm. The gratings, supported on ISMB 150mm, shall be placed at the formation level and will be covered with 100mm thick layer of broken/crushed/non-crushed stone having size 40mm to 60mm which acts as an extinguisher for flaming oil.

Each oil collection pit shall be drained towards a sump pit of size 1000X750mm and 500mm deep below the floor level within the collection pit whose role is to drain water and oil due to leakage within the collection pit so that collection pit remains dry.

19. FIRE PROTECTION WALLS

Fire protection walls shall be provided, if required

The firewall shall have a minimum fire resistance of 4 hours. The partitions, which are made to reduce the noise level, shall have the same fire resistance. The walls of the building, which are used as firewalls, shall also have a minimum fire resistance of 4 hours.

The firewall shall be designed to protect against the effect of radiant heat and flying debris from an adjacent fire.

The firewall shall extend 600 mm on each side of the Autotransformer / Reactors and 600 mm above the conservator tank or safety vent. A minimum of 2.0meter clearance shall be provided between the equipments e.g. Autotransformer/Reactors

and firewalls. In case of space constraints, these dimensions can be reduced as per the approval of owner.

The building walls, which act as firewalls, shall extend at least 1 m above the roof in order to protect it.

The firewall will be made of reinforced concrete (1:1.5:3 nominal mix).

7.3 ADMIXTURES & ADDITIVES

1. Only approved admixtures shall be used in the concrete for the Works. When more than one admixture is to be used, each admixture shall be batched in its own batch and added to the mixing water separately before discharging into the mixer. Admixtures shall be delivered in suitably labelled containers to enable identification.
2. Admixtures in concrete shall conform to IS:9103. The water proofing cement additives shall conform to IS:2645. Concrete Admixtures/ Additives shall be approved by Owner.
3. The Contractor may propose and the Owner may approve the use of a water-reducing set-retarding admixture in some of the concrete. The use of such an admixture will not be approved to overcome problems associated with inadequate concrete plant capacity or improperly planned placing operations and shall only be approved as an aid to overcoming unusual circumstances and placing conditions.
4. The water-reducing set-retarding admixture shall be an approved brand of Ligno-sulphonate type admixture.
5. The water proofing cement additives shall be used as required/ advised by the Owner.

8.0 Chainlink Fencing and Gate:

Fencing and Gate shall be provided at the locations shown in approved general arrangement drawing. Separate gate shall be provided for men and equipment. Fence shall also be provided for the various equipments (if) mounted on ground or a height lower than 2.5m. Necessary gates shall be provided for each area so surrounded. Fencing shall be constructed as per drawing attached with tender documents.

Chain link galvanised fence fabric with 3.15mm dia wire and 75mm mesh size conforming to IS: 2721 shall be used. MS tube used shall be of grade YST22 and conform to IS: 1161. All other structural steel shall conform to IS: 2062.

The whole assembly of tubular post shall be hot dip galvanized. The zinc coating shall be minimum 610 gram per sq. meter. The purity of zinc shall be 99.95% as per IS: 209. Frame of panels of chain link fencing shall be painted with two or more coats of approved standard synthetic enamel paint over approved standard steel primer.

The gate shall be made of medium duty M.S. pipe with welded joints. The main frame (outer frame) of the gate shall be made of 40mm dia pipe and vertical pipes of 15mm dia @ 125mm spacing (maximum) shall be welded with the main frame. Gate shall be painted with one coat of approved steel primer and two or more coats of synthetic enamel paint to give an even shade.

The height of the fencing shall be 1500mm on a toe wall of 300mm. Other details shall be as shown in the drawing.

9.0 WATER SUPPLY (EXTERNAL)

- (i) Water shall be made available by Owner (unless stated otherwise elsewhere) at any feasible point near scope boundary at single point to the contractor. Contractor shall state the total water requirement both in terms of quantity and head to the Owner.
- (ii) The contractor shall carry out all the external plumbing/erection works required for supply of water to the control room building beyond the single point as at (i).
- (iii) The contractor shall carry out all the plumbing/erection works required for supply of water to fire water tank beyond the single point as at (i).
- (v) A scheme shall be prepared by the contractor indicating the layout and details of water supply which shall be got approved from the Owner before actual start of work including all other incidental items not shown or specified but as may be required for complete performance of the works.
- (vi) Bore well is not in the scope of contractor.

10.0 TECHNICAL DETAILS OF THE BUILDINGS

1. 12mm cement plaster of mix 1:6 (1 cement : 6 coarse sand) shall be provided on the smooth side of internal walls.
2. 6 mm cement plaster of mix 1:3 (1 cement : 3 fine sand) to all ceiling.
3. 18mm Cement plaster of mix (1 cement: 5Coarse Sand) with under layer 12mm thick and top layer of 6mm thick for external plaster.
4. 12 mm thick pre-laminated three layer medium density (exterior grade) particle board Grade-I, Type II conforming to IS:12823 bonded with phenol formaldehyde synthetic resin, of approved brand and manufacture shall be provided in panelling fixed in aluminium doors, windows shutters and partition frames with C.P brass/stainless steel screws etc. for control room complete as per architectural drawings and directions of engineer-in-charge. The details shall be followed as per drawings and direction of Engineer-in-Charge.
5. Distemping on all internal walls and ceilings with oil bound washable distemper of approved brand and manufacture to give an even shade (two or more coats) over and including priming coat with cement primer for control room. In case of township painting shall be followed as per finishing schedule given in the drawing.
6. Plaster of Paris (Putty) of 2mm thickness over the plaster surface to prepare the surface even and smooth complete with distemping with first quality acrylic washable distemper (ready mix) of approved manufacturer with two or more coats of new work of required shade and colour complete as per manufacturer's specification.
7. Enamel Painting with synthetic enamel paint of approved brand and manufacture of required colour to give an even shade shall be provided on the steel glazed doors, windows, ventilators and rolling shutters in various buildings as specified in drawings. Two or more coats over an under coat of suitable shade with primer paint of approved brand and manufacture.
8. Two or more coats of French spirit polishing with a coat of wood filler shall be provided on the wooden doors.
9. Cement plaster skirting (up to 15 cm height) with cement mortar 1:3 (1 cement: 3 coarse sand) mixed with metallic concrete hardener in

same ratio as for floor finished with a floating coat of neat cement.
21 mm thick in ACDB/DCDB room

10. Polished vitrified tiles in 60x60 cm size (thickness to be specified by the manufacturer) in flooring and skirting, with water absorption's less than 0.08% and conforming to IS: 15622 of approved make in all colours and shades, laid on cement mortar 20mm thick for flooring & 12mm thick for skirting 1:4 (1 cement: 4coarse sand) including grouting the joints with white cement and matching pigments etc., complete.
11. Glazed Ceramic floor tiles 300x300mm (thickness to be specified by the manufacturer) of 1st quality conforming to IS:15622 of approved make in colours as approved by Engineer-in-charge in toilet and pantries area on 20mm thick cement mortar 1:4 (1 cement : 4coarse sand) including grouting the joints with white cement and matching pigments etc., complete.
12. Ceramic glazed wall tiles of 1st quality conforming to IS;15622 (thickness to be specified by the manufacture) of approved make in all colours, shades as approved by Engineer-in-Charge in skirting, risers of steps and dados over 12mm thick bed of cement Mortar 1:3 (1 Cement: 3 Coarse sand) and jointing with grey cement slurry @ 3.3kg per sqm including pointing in white cement mixed with pigment of matching shade complete.
13. Pre-cast terrazzo tiles 20mm thick with graded marble chips of sizes upto 12mm laid in floors, landings, skirting and riser of light shade using white cement jointed with neat cement slurry mix with pigment to match the shade of the tiles including rubbing and polishing complete with pre-cast tiles on Cement mortar 1:4 (1 cement : 4 coarse sand) with (20mm thick for flooring and 12mm thick for skirting).
14. Rajnagar plain white marble/Udaipur Grade Marble/Zebra black marble work gang socket (Polish and machine cut) of thickness 18mm for staircase in cement mortar 1:3 (1 Cement : 3 coarse sand) including rubbing, curing, pointing with an additional mixture of pigment to match the marble shade.
15. 18mm polished granite in cement mortar 1:4, 20mm thick made to a level cut to size shall be provided and laid as specified in drawings. The joints are filled with jointing compound matching to the tiles.

Wherever granite tiles are specified for the floor, 100mm granite skirting shall be provided with the walls. The granite outer surface shall be flushed to the plaster finish of the wall .

16. Granite counter shall be provided and fixed with 18mm granite slab mounted on 75mm RCC slab supported by 115mm brick wall plastered on all sides as per the drawing. The shelves shall be made of 18mm thick well cut and polished white marble slabs. The outer side of the brick wall and the RCC slab visible in the front shall be finished with 18mm granite with edges moulded on the exposed end. All other details shall be followed as per drawings.
17. All Brickwork shall be provided with cement mortar 1:6 (1cement: 6 coarse sand). Half brick work masonry shall be provided with cement mortar 1:4 (1cement: 4coarse sand). FPS Bricks of clay/Fly ash used shall be of class – 75.
18. Anti termite treatment shall be carried out for all buildings.
19. M.S. Rolling shutters as per drawing shall be provided and fixed interlocked together through their entire length and jointed together at the end by end locks mounted on specially designed pipe shaft with brackets along with ball bearing for rolling shutter, side guides and arrangements for inside and outside locking with push & pull operation including the cost of providing and fixing necessary 27.5 cm long wire springs grade No. 2 and M. S top cover of required thickness for rolling shutters. 80 x 1.25 mm M. S laths with 1.25 mm thick top cover.
20. Circular/hexagonal M.S. sheet ceiling fan box shall be provided in the ceiling with clamp of internal dia. 140 mm, 73 mm height, 3 mm thick rim, top and bottom lid of 1.5 mm M.S. Sheet. Lids shall be screwed in to M. S. box by means of 3 mm round headed screws, clamps shall be made of 12 mm dia. M. S. bar bent to shape as per standard drawing with overall length as 80 cm.
21. Powder Coated (minimum thickness 50 micron) aluminum work for doors, windows, ventilators and partitions shall be provided and fixed in – building with extruded built up standard tubular and other sections of approved make conforming to IS:733 and IS : 1285, fixed with rawl plugs and screws or with fixing clips, or with expansion hold fasteners including necessary filling up of gaps at junctions at top, bottom and sides with required PVC/neoprene felt etc and joined mechanically wherever required including cleat angle, Aluminium snap beading for glazing / panelling, C.P. brass/ stainless

steel screws including glazing and fittings as specified. All doors except for toilet and kitchen shall have 100mm 6 lever CP Brass mortice latch and lock with a pair of lever handle. Sliding door bolt of ISI marked (300x16mm) size shall be provided for toilet, kitchen and main door of control room/residential buildings.

All works shall be carried out as per drawings

22. Cement based water proofing treatment of roofs, balconies, terraces etc. shall be provided with average thickness of 120mm and minimum thickness at Khurra as 65mm and laid consisting of following operations:

(a) A slurry coat of neat cement using 2.75 kg/m² of cement admixed with proprietary water proofing compounds conforming to IS: 2645 shall be applied and grouted over the RCC slab including cleaning the surface before treatment.

(b) Plain Cement concrete 1:5:10 (1 Cement: 5 fine sand: 10 burnt brick aggregate of 40mm nominal size) admixed with proprietary water proofing compound conforming to IS: 2645 over 20mm thick layer of cement mortar of min 1:5 (Cement: 5 coarse sand) admixed with proprietary water proofing compound conforming to IS: 2645 to required slope and treating similarly the adjoining walls upto 300mm height including rounding of junctions of walls and slabs.

(c) After two days of proper curing a second coat of cement slurry admixed with proprietary water proofing compound conforming to IS: 2645 shall be applied.

(d) The surface shall be finished with 20mm thick joint less cement mortar of mix 1:4 (1 cement : 4 coarse sand) admixed with proprietary water proofing compound conforming to IS: 2645 and finally the surface shall be finished with trowel with neat cement slurry and making of 300 x 300 mm square.

(e) The whole terrace so finished shall be flooded with water for a minimum period of two weeks for curing and for final test. All above operations shall be done in order and as directed and specified by the Engineer-in-charge.

23. Unplasticised rigid PVC rain water pipes of 110mm dia shall be provided and fixed on the wall face conforming to IS:13592 type A as per drawing including jointing with seal ring conforming to IS:

- 5382 leaving 10mm gap for thermal expansion single socketed pipes including all fittings like bends, bat clamps gratings etc..
24. Unplasticised PVC Moulded fittings/accessories including 110mm bend and 110mm shoes shall be provided and fixed for unplasticised rigid PVC rain water pipes conforming to IS:13592 type A including jointing with seal ring conforming to IS: 5382 leaving 10mm gap for thermal expansion.
 25. Unplasticised PVC pipe clips of approved design shall be provided and fixed to unplasticised 110mm PVC rain water pipes by means of 50x50x50mm hard wood plugs, screwed with MS screws of required length including cutting brick work and fixing in cement mortar 1:4 (1 cement : 4 coarse sand) and making good the wall etc.
 26. Double action hydraulic floor spring of approved brand and manufacture IS:6315 marked "hardwyn" make (Model 3000) or equivalent for doors shall be provided and fixed at the following door including cost of cutting floors as required, embedding in floors and cover plates with brass pivot and single piece MS sheet outer box with slide plate etc. as per the direction of Engineer-in-charge. With stainless steel cover plate :
 - a. Main Entrance to Control Room Building / Transit Camp/Recreation Centre.
 - b. DGM room in control room.
 - c. Conference Room
 - d. Control Room
 27. Plinth protection 50 mm thick of cement concrete 1:2:4 (1 cement : 2 coarse sand : 4 graded stone) aggregate 20 mm nominal size) shall be laid over 75 mm bed of dry brick ballast 40 mm nominal size well rammed and consolidated and shall be grouted with fine sand including finishing the top smooth.
 28. Coloured vitreous china pedestal type water closet (European type) shall be provided with seat and lid, 10 liter low level vitreous china flushing cistern & C.P. flush bend with fittings and C.I. brackets, 40mm flush bend, overflow arrangement and mosquito proof coupling of including painting of fittings and brackets, cutting and making good the walls and floors wherever required.
 29. Providing and fixing coloured wash basin counter type of (630x450mm size) and flat back wash basin of (550 x400mm size) with C.I. Brackets 15mm C.P. brass pillar taps, close hole basin mixer 32mm C.P. brass waste and bottle trap of standard pattern, including painting of fittings and brackets, cutting and making good

the walls wherever required. Other details shall be as per the drawings.

30. All urinals shall be coloured vitreous china flat back half stall urinal of 580x380x350mm with 10 litre PVC automatic flushing cistern, Parryware/ Hindware/ Seabird/ Orient (Coral) with fittings, standard size C.P. brass flush pipe, spreaders with unions and clamps (all in C.P. brass) with waste fitting as per IS: 2556 C.I. trap with outlet grating and other couplings in C.P. brass including painting of fittings and cutting and making good the walls and floors wherever required.
31. Following fittings shall be provided in the toilets as per the drawings:
 - i) Toilet paper roll holder.
 - ii) Double type coat & hat hooks with flanges, fixed to wall / shutter, etc. with necessary screws, washers & plugs.
 - iii) CP liquid soap holder of approved make fixed with each wash basin to the wall with necessary CP brackets, CP screws, washers, plugs etc.
 - iv) 100mm dia vitreous chinaware half round channel of approved make fixed to correct grade, level, opening for floor trap below urinals set in CM 1:3 & pointed using white cement etc .
 - v) CP brass bib cock 15mm nominal bore of approved quality conforming to IS :8931 .
 - vi) CP brass angle valve of 15mm nominal bore provided and fixed in position for basin and cistern points of approved quality conforming IS :8931.
 - vii) Best quality marble partition slab provided and fixed in position for urinals, of size 610x1150mm, 20mm thick, polished on both sides & machine cut, exposed corners rounded etc.
 - viii) Towel rail of approved make of 600mm length, 25mm dia with a pair of brackets or flanges provided and fixed to wall beside each wash basin/set of wash basin with necessary screws, plugs, etc.
 - ix) 6mm thick beveled edge mirror 1000x600mm shall be provided and fixed mounted on 12mm thick water proof plywood backing and hardwood beading all-round and mirror fixed to the backing with 4 Nos. of CP cap screws & washers, including fixing the mirror to the

- wall with necessary screws, plugs & washers etc, with each wash basin.
32. Stainless steel AISI 304 (18/8) Kitchen sink of 460x915 mm bowl with depth of 178mm with drain board shall be provided and fixed as per IS 13983 with C.I brackets, and stainless steel plug 40mm with provision of 2 nos. CP brass long body bib cock conforming to IS Standard and weighing not less than 650 gm for CP bottle trap etc. including painting of fittings and brackets, cutting and making good the wall.
33. GI Pipe work for Internal and External works:
- i) All GI types and fittings shall conform to IS-1239 Part I & II for medium grade. All accessories shall be ISI Marked.
 - ii) All concealed GI pipe shall be painted with anticorrosive bitumastic paint including cutting of chases and making good the wall.
 - iii). All exposed GI pipes and fittings shall be painted with synthetic enamel paint of desired shade over a ready mixed priming coat, both of approved quality for new work.
 - iv). Wherever GI pipes are buried the same shall be provided and laid in position including trenching sand cushion and refilling, painted with anticorrosive bitumastic paint etc.
 - v). Gun metal ball valve with operating levers, non-return valves conforming to IS specification shall be provided and fixed in position as per drawing or direction of Engineer-in-charge.
34. Masonry chamber for sluice valve shall be 600x600mm size in plan and depth 750mm, or matching with the site condition inside with 50 class designation brick work in cement mortar 1:5 (1 cement : 5 fine sand) with CI surface box 100 mm. Top diameter, 160 mm bottom dia and 180 mm deep (inside) with chained lid and RCC top slab 1:2:4 mix (1cement : 2 coarse sand: 4 graded stone aggregate 20 mm nominal size) necessary excavation foundation concrete 1:5:10 (1 cement : 5 fine sand : 10 graded stone aggregate 40 mm nominal size) and inside plastering with cement mortar 1:3 (1 cement : 3 coarse sand) 12 mm thick finished with a floating coat of neat cement complete as per standard design with FPS bricks of class 75.
35. Polyethylene water storage tanks conforming to ISI: 12701 shall be provided of approved brand and manufacture with cover and suitable locking arrangement, float valve and making necessary

holes for inlet, outlet and overflow pipes. Capacity of water tank shall be 2x2000 litres for control room, 2000 litres for Transit Camp, 1000 litres for D type & Recreation Centre and 500 litres each for other dwelling unit.

36. PVC floor traps of self cleansing design shall be provided & fixed in position with outlet size of 75mm diameter of approved make, including making connection with PVC soil/waste pipes using rubber gaskets, embedding the trap in 150 mm thick PCC 1:2:4, providing & fixing of top tile & strainer of CP or PVC on top of the trap etc.
37. Square-mouth SW gully trap grade 'A' 100x100mm size P type with FPS Bricks class designation 75 shall be provided and fixed complete with CI grating brick masonry chamber with water tight C.I. cover with frame of 300X300mm size (inside) the weight of cover to be not less than 4.5 Kg and frame to be not less than 2.70 Kg as per standard design
38. Brick Masonry road gully chamber of 50x45x60cm shall be provided with brick with cement mortar 1:4 including 500x450mm pre cast RCC Horizontal/vertical grating with frame complete.
39. Glazed stoneware pipes of 150mm diameter grade 'A' shall be provided, laid and jointed with stiff mixture of cement mortar in the proportion of 1:1 (1cement :1 fine sand) including testing of joints etc. complete.
40. Cement concrete 1:5:10 (1 cement: 5 coarse sand: 10 graded stone aggregate 40 mm nominal size) shall be provided and laid around S.W pipes including bed concrete.
41. Brick masonry manhole shall be constructed in cement mortar 1:4 (1 cement :4 coarse sand) RCC top slab with 1:2:4 mix (1 cement : 2coarse sand : 4 graded stone aggregate 20 mm nominal size) foundation concrete 1:4:8 mix (1cement : 4 coarse sand :8 graded stone aggregate 40 mm nominal size) inside plastering 12 mm thick with cement mortar 1:3 (1 cement : 3 coarse sand) finished with floating coat of neat cement and making channels in cement concrete 1:2:4 (1 cement: 2 coarse sand :4 graded stone aggregate 20 mm nominal size) finished with a floating coat of neat cement complete as per standard design.
 - a) Inside size shall be 90 x 80 cm and 60 cm deep including CI cover with frame (light duty) 455 x 610 mm internal dimensions total weight of cover and frame shall not be less than 38 kg (weight of cover 23 kg and weight of frame 15 kg) and shall be

constructed with F.P.S./fly ash bricks with class designation 75.

- b) Inside size shall be 120 x 90 cm and 90 cm or more deep including CI cover with frame (medium duty) 500mm internal diameter total weight of cover and frame to be not less than 116 kg (weight of cover 58 kg and weight of frame 58 kg) with FPS Bricks class designation 75.
- 42. MS foot of 20 x 20mm square rests shall be provided and fixed in manholes with 20 x 20 x 10 cm cement concrete blocks 1:3:6 (1 cement :3 coarse sand :6 graded stone aggregate 20 mm nominal size) as per standard design.
- 43. Steel glazed doors, windows and ventilators of standard rolled steel sections shall be provided and fixed in Township pumphouse and FFPH building jointed and welded with 15 x 3 mm lugs, 10cm long, embedded in cement concrete blocks 15 x 10 x10 cm of 1:3:6 (1 cement 3 coarse sand : 6 graded stone aggregate 20mm nominal size) or with wooden plugs and screws or rawl plugs and screws or with fixing clips or with bolts and nuts as required, including providing and fixing of glass panes with glazing clips and special metal sash putty of approved make complete including applying a priming coat of approved steel primer, necessary hinges or pivots as required to complete the work.
- 44. Pressed steel door frames manufactured from commercial mild steel sheet of 1.25mm thickness shall be provided and fixed in Township pumphouse and FFPH building including hinges jamb, lock jamb, bead and if required angle threshold of mild steel angle of section 50x25mm, or base ties of 1.25 mm pressed mild steel welded or rigidly mixed together by mechanical means, adjustable lugs with split end tail to each jamb including steel butt hinges 2.5mm thick with mortar guards, lock strike-plate and shock absorbers as specified and applying a coat of approved steel primer after pre-treatment of the surface as directed by Engineer-in-Charge.
- 45. Asbestos cement 6mm thick corrugated sheets roofing shall be provided and fixed with G, I, J or L hooks, bolts and nuts 8mm diameter G, I plain and bitumen washers complete excluding the cost of purlins, rafters and trusses for water tank.
- 46. Water closet squatting pan (Indian type W.C. pan) (white vitreous china Orissa pattern W.C. pan of size 580x440mm with integral type foot rests) shall be provided with 100mm sand cast iron P or S trap. 10 litre low level white P.V.C flushing cistern with manually

controlled device (handle lever) conforming to IS:7231, with all fittings and fixtures complete including cutting and making good the walls and floors wherever required.

47. Coloured vitreous china pedestal type water closet (European type) shall be provided with seat and lid, 10 litre low level white vitreous china flushing cistern & C.P. flush bend with fittings and C.I. brackets, 40mm flush bend, overflow arrangement with specials of standard make and mosquito proof coupling of approved municipal design complete including painting of fittings and brackets, cutting and making good the walls and floors wherever required.
48. Coloured vitreous china flat back half stall urinal of size 580x380x350mm shall be provided with 5 litre PVC automatic flushing cistern, with fittings, standard size C.P. brass flush pipe, spreaders with unions and clamps (all in C.P. brass) with waste fitting as per IS:2556 C.I. trap with outlet grating and other couplings in C.P. brass including painting of fittings and cutting and making good the walls and floors wherever required.
49. Wash basin counter type (630x450mm) and flat back wash basin (550 x400mm) shall be provided with C.I. Brackets 15mm C.P. brass pillar taps, close hole basin mixer 32mm C.P. brass waste and bottle trap of standard pattern, including painting of fittings and brackets, cutting and making good the walls wherever required. Other details shall be as per the drawings.
50. Ward Robes for township quarters and Recreation Center shall be as per the drawing. Hardware fittings shall have 100mm CP brass handle, 50mm CP Brass cup-board locks, Nickel Plated finishing, Piano hinges as per IS:3818, Magnetic catchers, heavy type hanger rods of 20mm dia, Anodized (Grade AC-10) Aluminium tower bolts(10o x10m) of ISI marked of required shade. All doors of recreation center and Transit Camp shall have tubular type Hydraulic Door Closer conforming to IS-3564.
51. All doors except toilet and kitchen shall have 100mm 6 liver mortice lock and a pair of lever handles with necessary screws complete etc.
52. Aluminium sliding door with ISI marked anodized transparent and dyed to required colour or shade shall be provided at main entry door, toilets and kitchen.
53. Pelmet shall be provided 18mm thick 150mm wide of coir veneer board ISI marked including top cover of 6mm of coir veneer board and lipping, Nickel plated MS pipe 20mm dia (heavy type0 curtain

road with Nickel plated (including fixing with 25x 3mm MS flat 10cm long and rawl plug all complete.

54. Cement Jaali of (1:2:4) (1 Cement: 2 fine aggregate : 4 coarse aggregate) 50mm thick, shall be reinforced with 1.6mm dia with Mild steel wire including centring and shuttering cleaning fixing and furnishing with cement mortar 1:3).
55. Providing and fixing 15mm thick approximately 600 X 600mm Mineral fibre board panel along with false ceiling and making cut-outs for electrical fixtures, AC diffusers, openable access etc complete as per the drawings with silhouette profile system with 15mm wide flange incorporating 6mm central recess white / black main runners at 1200mm centre-centre and not greater than 600mm from the adjacent wall. The cross tees shall be provided to make a module of approximately 600mm X 600mm by fitting 600 mm long cross tees centrally placed between 1200 mm long cross tees .Cross tees also have 15mm wide flange incorporating 6mm central recess white/black. The module formed above shall be anchored to the slab with channels or angles, suspenders as per manufacturer's specifications. It shall be provided in all the AC area of Control Room and in the Transit Camp of Township as specified in the Drawing.
56. The Tiles / Paver Blocks shall be made of white cement in order to accentuate the vibrancy of colours and to ensure the increased natural sheen of the tile / block with regular use and maintenance with an aggregate mix not leaner than 1:3 and shall be free from the use of undesirable substitutes such as slag / red mud. Moreover the pigments used in each and every tile / block shall be imported Bayer pigments which have a higher colour consistency and fade resistance. Moreover the pigments shall also have higher UV stability and should not fade / crack in the exterior weather conditions.

The Contractor shall ensure that the material is brought on site in a packed condition with minimal / no damages or breakages in transit. The thickness of Floor Tiles shall be 22mm and that of Flexi Paver Block shall be 60mm.

The Concrete Tiles & Flexi Pavers shall be laid over cement mortar 1:4 (1 cement: 4Coarse sand) over an average thickness of 25mm. The base shall be 100mm thick PCC 1:4:8. The jointing shall be done with white cement mixed with pigment matching to the tiles.

11.0 MODE OF MEASUREMENT

11.1 Earthwork

This shall include excavation in all kinds of soil including rock, all leads and lifts including back filling, compacting, dewatering (if required) and disposal of surplus earth to a suitable location. The quantity of excavation for foundations of towers, equipment structures, all transformers, firewall, cable trenches, water tank, reactors, buildings and underground water tanks, covered car parking shall only be measured. The quantity of excavation for roads, rail cum road, drains, rainwater harvesting, septic tank, soak pit, external water supply system, site surfacing, chain link fencing (including gate) shall not be measured separately and shall be deemed to be included in the composite rates quoted by the bidder for the respective works. All other excavation required for the completion of the work including fixing of lamp posts, plinth protection, flooring, sewerage system, manholes, pipes, earthmat etc. shall also not be paid for. The measurement of excavation of all concrete works shall be made considering dimension of the pit leaving 150mm gap around the base pad (lean concrete) or actually excavated pit, whichever is less. The quantity shall be measured in cubic metres.

11.2 PCC

Providing and laying Plain Cement Concrete of all types and at all locations including all leads and lifts. The quantity shall be measured in cubic meters as per lines and levels indicated in the drawings.

11.2.1 PCC 1:2:4 (1 cement : 2 sand : 4 coarse aggregate 20 mm nominal size) shall be measured in flooring of buildings, plinth protection, fencing, transformer foundation, reactor foundation, rail track, drain, culverts, septic tank, chain link fencing, gate etc. as indicated in the drawings.

11.2.2 PCC 1:4:8 (1 cement : 4 coarse sand : 8 stone aggregate, 40mm nominal size) shall be measured below all foundations of buildings, underground water tanks, covered car parking cable trench, roads, under flooring, rail-cum-road, transformer foundation, reactor foundation, drain, water tank, culverts, gate etc. as indicated in the drawings.

11.2.3 PCC 1:5:10 (1 Cement: 5 sand brick aggregate, 40mm nominal size) shall be provided for site surfacing in switchyard, roof water proofing etc. All other PCC required for the completion of the work including hold fasts of doors/windows/rolling shutters, fixing of plumbing pipes, bedding concrete for sewer lines, embedment of electrical conduits etc. shall not be measured and deemed included in the composite rates quoted by the bidder for respective works. Water proofing compound wherever specified shall be added without any extra cost.

11.3 RCC

Measurement of reinforced cement concrete at all locations shall be made and shall include all leads, lifts, formwork, grouting of pockets and underpinning, (but shall exclude reinforcement), of nominal mix 1:1.5:3 (1cement : 1.5 coarse sand : 3 stone aggregate 20mm nominal size). This shall also include pre-cast RCC work and addition of water proofing compound wherever required for which no additional payment shall be made. The quantity shall be measured in cubic meters as per lines and levels indicated in the drawings. No deduction shall be made for volume occupied by reinforcement/inserts/sleeves and for openings having cross-sectional area up to 0.1 sq.m.

11.4 Steel Reinforcement

Reinforcement shall be measured in length (actual or theoretical as per drawing whichever is less) including hooks, if any, separately for different diameters as actually used in work, excluding overlaps. From the length so measured, the weight of reinforcement shall be calculated in tones on the basis of sectional weights as adopted by Indian Standards. Wastage, overlaps, couplings, welded joints, spacer bars, chairs, stays, hangers and annealed steel wire or other methods for binding and placing shall not be measured and cost of these items shall be deemed to be included in the rates for reinforcement.

11.5 Stone filling

Measurement of stone (40mm nominal size) for transformer foundations shall be made as per theoretical volume of the space to be filled in the transformer foundation as per drawings. This shall be measured in cu.m.

11.6 Miscellaneous structural steel

Measurement for Supply, fabrication, transportation and erection of all miscellaneous structural steel work for mono rails (RS joists), rails for transformers/ reactors, trusses, frame work, purlins, gratings, steel tubes, built up sections along with all other steel fittings and fixtures, inserts and embedment in concrete shall be made as per drawings. The unit rate for this item shall be inclusive of cutting, grinding, drilling, bolting, welding, pre- heating of the welded joints, applying a priming coat of steel primer and anti corrosive bitumastic paint/ synthetic enamel paint etc. (wherever specified), setting of all types of embedment in concrete, etc. Steel required for foundation bolts, nuts and bolt, doors, windows, ventilators, louvers, rolling shutters, chain link fencing, gratings in drains, soil pipes, plumbing pipes, floor traps, embedment's required for rainwater harvesting, septic tank, soak pit, roof truss and purlins required for fire water tank, etc. shall not be considered for payment and measurements.

Quantity shall be measured in Kg.

11.7 Roads

- A). The measurement for the concrete road shall be made on the basis of area in square meter (M²) of top concrete completed surface of the road and shall be deemed to include all items such as excavation, compaction, rolling, watering, WBM, Kerb stone, grating, shoulder, interlocking tiles etc where ever indicated complete as per drawing but excluding concreting and reinforcement.
- B) The measurement of bituminous road shall be made on the basis of area in square meter (M²), of the top bituminous completed surface of the road and shall include all items such as excavation, compaction, rolling, watering, sub base course, WBM, shoulder, premix carpet etc complete as per drawing.

11.9 Antiweed Treatment and Stone Spreading

The measurement shall be done for the actual area in square metres of stone spreading provided in the switchyard and shall include antiweed treatment including material and providing and spreading of 100mm thickness of uncrushed/crushed/broken stone of 40mm nominal size as per the specification for the specified area.

11.10 Chain Link Fencing and gate

The measurement shall be made in running metres of the fence provided as per drawing. The rate shall be including the post, fencing, MS Flat etc. complete but excluding the concrete. The gate shall be measured in numbers.

11.11 External Finishing:

This is a lump sum item. Contractor has to assess the quantity as per drawings of Control room cum administrative building, Fire Fighting Pump House, switchyard panel room, township buildings, covered parking and quote for the same for each building separately. This shall include following items.

- 1) External plastering: 18 mm cement plaster of mix: 1:4 (1 cement: 4 coarse sand) including all grooves as specified.
- 2) Providing and applying two or more coats with of Acrylic exterior flat paint over an under coat of suitable primer on

new cement plaster surfaces of the control room / FFPH building. For township building and covered parking it shall be as per drawing. It shall be inclusive of required tools, scaffolding, materials and other painting accessories etc. as per recommendations of manufacturer.

11.12 Hume Pipe

Hume pipe shall be measured diameter-wise and laid as per the drawings and shall be measured in running metres. The item shall be inclusive of excavation, laying, back filling, jointing etc. but excluding concrete and reinforcement (if any).

11.13 Building

This is a lump sum item for each building. However, the quantity of excavation, concrete, reinforcement below the plinth level shall be measured as per item nos. 11.1, 11.2, 11.3 & 11.4 described above. Quantity of concrete and reinforcement above the plinth level of the buildings shall be measured and paid under item no. 11.2, 11.3 & 11.4 mentioned above respectively. External Finishing shall be measured and paid as per item no. 11.11 mentioned above. The rest of the entire work required to complete the building in all respect as per the drawings furnished by the Owner shall be deemed to be included in this lump sum rate.

11.14 Rain Water Harvesting

This is a lump sum item. The contractor shall be required to complete the work in all respect as per drawings furnished by the Owner. All the items including excavation, miscellaneous steel, brick work, fillings of boulders, gravel, sand, pipes etc. shall be deemed to be included in this lump sum rate. However, the concrete (all types) and the reinforcement shall be measured and paid under the item no. 11.2, 11.3 & 11.4 mentioned above.

11.15 Rail cum Road

The measurement for the rail cum road shall be made in square metres of top concrete completed surface of the rail cum road and shall include all items such as excavation, compaction, rolling, watering, WBM etc. complete as per drawing but excluding concrete, reinforcement, structural steel and rails.

11.16 Septic Tank and Soak Pit

This is a lump sum item. The contractor shall be required to complete the work in all respect as per drawings furnished by the Owner. All the items including excavation, masonry work, all types of fillings, all types of pipes including plumbing and vent pipes, all type of fittings etc. shall be deemed to be included in this lump sum rate. However, the concrete (all types) and the reinforcement shall be measured and paid under the item no. 11.2, 11.3 & 11.4 mentioned above.

11.17 Fire Water Tank

This is a lump sum item. The contractor shall be required to complete the work in all respect as per drawings furnished by the Owner. All the items including excavation, compaction, brick work, roof truss, corrugated AC Sheet roofing, all types of miscellaneous steel, internal and external plastering, painting etc. shall be deemed to be included in this lump sum cost. However, the concrete (all types), reinforcement and the steel embedments (except roof truss and purlins) shall be measured and paid under the item no. 11.2, 11.3 and 11.6 mentioned above.

11.18 External water supply from Bore-well to Fire water tank, Control Room Building and township buildings.

The external water supply from Bore-well shall be measured diameter-wise in running metres. It shall include all the items such as excavation, piping, pipe fittings, painting, brickwork, sand filling, concrete, valves, chambers cutting chases in walls, openings in RCC and repairs, etc. required to complete the job.

11.19 External Sewage System of the township shall be measured diametric ways in running meters. It shall include all the items such as excavation, piping, pipe fittings, manholes, gali trap, gali chamber casing in concrete and repairs etc required to complete the job. Any modification in the existing sewage system, if required, shall be done by the Contractor without any extra cost implicated to Employer.

11.20 Township Pumphouse

This is a lump sum item including pumphouse, pumps & accessories, piping within pumphouse, inserts in water pump etc. complete. However, the concrete (all types), reinforcement and the steel embedments shall be measured and paid under the item no. 11.2, 11.3 11.4 and 11.6 mentioned above.

12.0 MISCELLANEOUS GENERAL REQUIREMENTS

- 12.1 Dense concrete with controlled water cement ratio as per IS-code shall be used for all underground concrete structures such as pump-house, tanks, water retaining structures, cable and pipe trenches etc. for achieving water-tightness.
- 12.2 All joints including construction and expansion joints for the water retaining structures shall be made water tight by using PVC ribbed water stops with central bulb. However, kicker type (externally placed) PVC water stops shall be used for the base slab and in other areas where it is required to facilitate concreting. The minimum thickness of PVC water stops shall be 5 mm and minimum width shall be 230 mm.
- 12.3 All mild steel parts used in the water retaining structures shall be hot-double dip galvanised. The minimum coating of the zinc shall be 750 gm/sq. m. for galvanised structures and shall comply with IS:2629 and IS:2633. Galvanizing shall be checked and tested in accordance with IS: 2633. The galvanizing shall be followed by the application of an etching primer and dipping in black bitumen in accordance with BS: 3416.
- 12.4 FPS Bricks of clay/ fly ash having minimum 75 kg/cm² compressive strength can only be used for masonry work. Contractor shall ascertain himself at site regarding the availability of bricks of minimum 75 kg/cm² compressive strength before submitting his offer.
- 12.5 Angles 50x50x5 mm (minimum) with lugs shall be provided for edge protection all round cut outs/openings in floor slab, edges of drains supporting grating covers, edges of RCC cable/pipe trenches supporting covers, edges of manholes supporting covers, supporting edges of manhole precast cover and any other place where breakage of corners of concrete is expected.
- 12.6 Anti termite chemical treatment shall be given to column pits, wall trenches, foundations of buildings, filling below the floors etc. as per IS: 6313 and other relevant Indian Standards.
- 12.7 The protections required to be carried out for aggressive alkaline soil, black cotton soil or any other type of soil which is detrimental/harmful to the concrete foundations shall be payable separately if the same is not covered in BPS.

- 12.8 For all civil works covered under this specification, nominal mix by volume batching as per CPWD specification is intended. The relationship of grade of concrete and ratio of ingredients shall be as below :

S.No.	Mix	Cement	Sand	Coarse aggregate of 20 mm down grade as per IS 383
1.	M 10	1	3	6
2.	M 15	1	2	4
3.	M 20	1	1.5	3

The material specification, workmanship and acceptance criteria shall be as per approved standard Field Quality Plan attached with this document. In case certain item is not covered in FQP, it shall be constructed as per CPWD specification..

- 12.9 Ready mix concrete pertaining to M20 grade of reputed manufacturer such as Lafarge, ACC, Ultra Tech, RMC Readymix India etc. or manufacturer of similar repute shall also be accepted for use in construction activity. Materials specification, workmanship and acceptance criteria of readymix concrete shall be as per IS-456.

- 12.10 Items/components of buildings not explicitly covered in the specification but required for completion of the project shall be deemed to be included in the scope.

13.0 **INTERFACING**

The proper coordination & execution of all interfacing civil works activities like fixing of conduits in roofs/walls/floors, fixing of foundation bolts, fixing of lighting fixtures, fixing of supports/embedment, provision of cut outs etc. shall be the sole responsibility of the Contractor. He shall plan all such activities in advance and execute in such a manner that interfacing activities do not become bottlenecks and dismantling, breakage etc. is reduced to minimum.

14.0 **STATUTORY RULES**

- 14.1 Contractor shall comply with all the applicable statutory rules pertaining to factories act (as applicable for the State). Fire Safety Rules of Tariff Advisory Committee. Water Act for pollution control etc.
- 14.2 Statutory clearance and norms of State Pollution Control Board shall be followed as per Water Act for effluent quality from plant.

- 14.3 Requirement of sulphate resistant cement (SRC) for sub structural works shall be decided in accordance with the Indian Standards based on the findings of the detailed soil investigation.
- 14.4 All building/construction materials shall conform to the best quality specified in CPWD specifications if not otherwise mentioned in this specification.
- 14.5 All tests as required in the standard field quality plans have to be carried out.

POWERGRID CORPORATION OF INDIA LIMITED
(Quality Assurance & Inspection Deptt.)

**STANDARD FIELD QUALITY PLAN
FOR SWITCHYARD CIVIL WORKS**

Section : FOUNDATION MATERIALS

Sl. No.	Component/Operation & Description of Test	Sampling Plan with basis	Ref. Document & acceptance norm	Testing Agency	Remarks	Check
1.	CHECKING OF FOUNDATION MATERIALS					
A)	CEMENT					
i)	Fineness	One sample per lot of 100 MT or part thereof from each source for MTCs and one sample per lot of 200 MT or part thereof from each source for site testing	IS:456, IS:269 IS:8112, IS:12269 IS:1489 & POWERGRID specification	Manufacturer/ POWERGRID approved lab	Review of manufacturers test certificates (MTCs) and laboratory test results by POWERGRID	B
ii)	Compressive Strength					
iii)	Initial & final setting time					
iv)	Soundness					
v)	Heat of Hydration for low heat cement (Not applicable for OPC & PPC)					
vi)	Chemical Composition of Cement	One sample per lot of 100 MT or part thereof from each source for MTCs	IS:456, IS:269 IS:8112, IS:12269 IS:1489 & POWERGRID specification	Manufacturer	Review of manufacturers test certificates by POWERGRID	B
B)	COARSE AGGREGATES					
i)	Determination of Partical size (Sieve Analysis)	One sample per lot of 100 cubic meter or part thereof from each source for each size	IS:383, IS:2386 and POWERGRID specification	POWERGRID approved lab. However, Moisture content test for design mix concrete shall be done on all days of concreting at site.	Each source to be approved by POWERGRID Review and acceptance of test result by POWERGRID.	B
ii)	Flakiness Index					
iii)	Crushing Value					
iv)	Specific Gravity*					
v)	Bulk Density*					
vi)	Absorption Value*					
vii)	Moisture Content*					
viii)	Soundness of Aggregate**					
ix)	Presence of deleterious materials					
	* Applicable Design concretes only	** Applicable to concrete work subject to frost action				

POWERGRID CORPORATION OF INDIA LIMITED
(Quality Assurance & Inspection Deptt.)

C)	FINE AGGREGATE					
i)	Gradation/Determination of Particle size (Sieve Analysis)	One sample per lot of 100 cubic meter or part thereof from each source	IS:383,IS:2386,IS:456 and POWERGRID specification	POWERGRID approved lab. However Moisture content test for design mix concrete shall be done on all days of concreting at site.	Each source to be approved by POWERGRID Review and acceptance of test result by POWERGRID.	B
ii)	Specific Gravity and density					
iii)	Moisture content					
iv)	Absorption Value					
v)	Bulking					
vi)	Silt Content Test					
vii)	Presence of deleterious materials					
D)	BRICKS					
i)	Dimensional tolerance	As per enclosed Annexure-II	CPWD & POWERGRID specification	POWERGRID approved Lab.	Approved by POWERGRID	B
ii)	Compressible Strength					
iii)	Water Absorption					
iv)	Efflorescence					
E)	WATER					
i)	Cleanliness (Visual Check)	Random	IS:456, IS:3025 and POWERGRID specification. The water used for mixing concrete shall be fresh, clean and free from oil, acids and alkalies, organic materials, or other deleterious materials	Contractor	Each source to be approved by POWERGRID	B
ii)	Chemical and physical properties of water for checking its suitability for construction purposes	One sample per source	IS:456, IS:3025 and POWERGRID specification	Contractor/ POWERGRID Approved Lab	Approved by POWERGRID	B
	*Applicable to design mix concretes only					

POWERGRID CORPORATION OF INDIA LIMITED
(Quality Assurance & Inspection Deptt.)

Sl. No.	Component/Operation & Description of Test	Sampling Plan with basis	Ref. Document & acceptance norm	Testing Agency	Remarks	Check
1.	REINFORCEMENT STEEL					
i)	Identification & size	Random	IS:432, IS:1139, IS:1786 & POWER GRID specification	Contractor	Approved by POWERGRID	B
ii)	Chemical Analysis Test	One sample per heat	IS:432, IS:1139, IS:1786 POWERGRID specification	Manufacturer	Review of manufacturers test certificates by POWERGRID	B
iii) iv) v)	Tensile Test Yield stress/proof stress Percentage Elongation	One sample per lot of 40 MT or part thereof for each size of steel conforming to IS: 1139 and 5 MT or part thereof for HDS wire for each size of steel as per IS: 432. For steel as per IS:1786 under 10mm 1 sample for each 25 MT or part thereof. 20 mm-16 mm 1 sample for each 35 MT or part thereof. Over 16mm 1 sample for each 45 MT or part thereof	IS:432, IS:1139, IS:1786 POWER GRID specification	Manufacturers/ POWERGRID approved lab	Review of manufacturers test certificates as well as lab test results by POWERGRID	B
vi)	Bend/Rebend Test	One sample per lot of 20 MT or part thereof for each size of steel as per IS:432, IS:1139. For steel as per IS:1786 under 10mm-16mm 1 sample for each 25MT or part thereof 10 mm-16mm 1 sample for each 45 MT or part thereof.	IS:432, IS:1139, IS:1786 POWER GRID specification	Manufacturers/ POWERGRID	Review of manufacturers test certificates as well as lab test results by POWERGRID	B
vii)	Reverse Bend Test for HDS wire	One sample per lot of 5 MT or part thereof for each size	IS:432 POWER GRID specification	Manufacturer/ POWERGRID approved lab	Review of manufacturers test certificates as well as lab test result by POWERGRID	B

POWERGRID CORPORATION OF INDIA LIMITED
(Quality Assurance & Inspection Deptt.)

Section : FOUNDATION

Sl. No.	Component/Operation & Description of Test	Sampling Plan with basis	Ref. Document & acceptance norm	Testing Agency	Remarks	Check
C.	STRUCTURAL STEEL USED IN CABLE TRENCHES & FOUNDATIONS					
i)	Dimensional Check	Random	POWERGRID Specification & approved drawing	Contractor	Checklist to be prepared and signed jointly	B
ii)	Visual Check for damages, rusting, Pitting etc.	100%	POWERGRID Specification & approved drawing	Contractor	Checklist to be prepared and signed jointly	C
iii)	Visual Check for welding, defects, primer, coating and painting/galvanizing as applicable	Random	POWERGRID specification & approved drawings	Contractor	Checklist to be prepared and signed jointly	C
iv)	Physical properties of structural steel	1 sample per lot of 40 MT or part thereof for tensile tests and 1 sample per lot of 20 MT or part thereof for bend test for each size.	IS:2062, POWERGRID specification & approved drawings	Manufacturer/ POWER GRID Approved lab	Review of Mfgs. Test certificates as well as lab test results by POWERGRID	B

POWERGRID CORPORATION OF INDIA LIMITED
(Quality Assurance & Inspection Deptt.)

Sl. No.	Component/Operation & Description of Test	Sampling Plan with basis	Ref. Document & acceptance norm	Testing Agency	Remarks	Check
2.	GANTRY/EQUIPMENT FOUNDATION/ CABLE TRENCH					
A.	BEFORE EXCAVATION					
i)	Checking of pegs condition as per line and alignment	100% on each location	IS:4091, IS:3764 & POWERGRID approved drawings/specification	Contractor	Approval by POWERGRID	C
ii)	Checking of pit making as per drawing & RL	100% on each location	IS:4091, IS:3764 & POWERGRID approved drawings/specification	Contractor	Approval by POWERGRID	C
B.	EXCAVATION					
i)	Dimensional conformity	Each location	IS:4091, IS:3764 & POWERGRID approved drawings/specification	Contractor	Approval by POWERGRID (JMC/MB)	B
ii)	Verticality/slopes & Squareness of each pit	Each location	IS:4091, IS:3764 & POWERGRID approved drawings/specification	Contractor	Checklist to be prepared and signed jointly	B
iii)	Verification of classification of foundation wherever applicable	Each location	IS:4091, IS:3764 & POWERGRID approved drawings/specification	Joint inspection by POWER GRID and contractor	Approval by POWERGRID	B
C.	FOUNDATION BOLTS/MATALLIC INSERTS					
i)	Check for proper	100%	POWERGRID	Contractor	Checklist to be	C

POWERGRID CORPORATION OF INDIA LIMITED
(Quality Assurance & Inspection Deptt.)

	identification foundation bolts w.r.t type of foundation		specification & approved drgs.		prepared and signed jointly	
ii)	Visual check for mechanical damage and galvanising/ painting if applicable for metallic insert	100%	POWERGRID specification & approved drgs.	Contractor	Checklist to be prepared and signed jointly	C
iii)	Alignment & Level	100%	POWERGRID specification & approved drgs.	Contractor	Checklist to be prepared and signed jointly	B
iv)	Grouting/Underpinning of foundation base plate	100%	POWERGRID specification & approved drgs.	Contractor	Checklist to be prepared and signed jointly	C
D.	P.C.C. Padding	For all locations	IS:456 and POWERGRID approved foundation drawings & specification	Joint inspection by POWER GRID and contractor	Approval by POWERGRID	B
E.	SHUTTERING(Form work)					
i)	Check for materials, breakage or damage	100%	IS:456, POWERGRID specification/ approved drawings	Joint inspection by POWER GRID and contractor	Approval by POWERGRID	C
ii)	Check for plumb, alignment parallelism, squareness and equidistance from stub	100% casting	IS:456, POWERGRID specification/ approved drawings	Joint inspection by POWER GRID and contractor	Approval by POWERGRID	B
iii)	Dimensional check	100% before casting	IS:456, POWERGRID specification/ approved drawings	Joint inspection by POWER GRID and contractor	Approval by POWERGRID	B
iv)	Check for level & height	100% before casting	POWERGRID specification/ approved drawings	Joint inspection by POWER GRID and contractor	Approval by POWERGRID	B
v)	Check for rigidity of	100%	POWERGRID	Joint	Approval by	B

POWERGRID CORPORATION OF INDIA LIMITED
(Quality Assurance & Inspection Deptt.)

	frame/tightness		specification/ approved drawings	inspection by POWER GRID and contractor	POWERGRID	
vi)	Cleaning and oiling	100%	POWERGRID specification/ approved drawings	Joint inspection by POWER GRID and contractor	Approval by POWERGRID	B
vii)	Diagonal bracing if required as per drawings/site conditions	100%	POWERGRID specification/ approved drawings	Joint inspection by POWER GRID and contractor	Approval by POWERGRID	C
viii)	Checking of joints to avoid undue loss of cement slurry	100%	POWERGRID specification/ approved drawings	Joint inspection by POWER GRID and contractor	Approval by POWERGRID	C
E.	PLACEMENT OF REINFORCEMENT STEEL					
i)	Check the steel bars for rust, cracks, surface flaws, laminates etc. (Visual check)	100%	IS:456 and POWERGRID specification/ approved drawings	Joint inspection by POWER GRID and contractor	Approval by POWERGRID	C
ii)	Check as per the bar bending schedule before placement of concrete	For all locations	IS:456,IS:2502 and POWERGRID specification/ approved drawings	Joint inspection by POWER GRID and contractor	Approval by POWERGRID (Pour Card)	B
iii)	Check cutting tolerance for bars as per check list/drawings. Check whether all the bent bars and lap lengths are as per approved bar bending schedule	For all locations	IS:456,IS:2502 and POWERGRID specification/ approved drawings	Joint inspection by POWER GRID and contractor	Approval by POWERGRID (Pour Card)	B
iv)	Check whether all joints & crossing of bars are tied properly	100%	IS:456 and POWERGRID specification/ approved drawings	Joint inspection by POWER GRID and contractor	Approval by POWERGRID	C

POWERGRID CORPORATION OF INDIA LIMITED
(Quality Assurance & Inspection Deptt.)

	with right guage & annealed wire as per specification		approved drawings	GRID and contractor		
v)	Check for proper cover distance spacing of bars, spacers, & chairs after the reinforcement cage has been put inside the formwork	100%	IS:456 and POWERGRID specification/ approved drawings	Joint inspection by POWER GRID and contractor	Approval by POWERGRID	C
vi)	Check whether lapping of bars are tied properly with right gauge and annealed wire as per specification	100%	IS:456 and POWERGRID specification/ approved drawings	Joint inspection by POWER GRID and contractor	Approval by POWERGRID	B
G.	PILE FOUNDATION (Additional Tests)					
i)	Check of centre line of pile group	Each pile group	IS:2911 & POWERGRID approved pile foundation drawings/specification	Joint inspection by POWER GRID and contractor	Checklist to be prepared and signed jointly	B
ii)	Check pile location	Each pile	IS:2911 & POWERGRID approved pile foundation drawings/specification	Joint inspection by POWER GRID and contractor	Checklist to be prepared and signed jointly	B
iii)	Temporary casing tube & permanent liner also check thickness of liner material (if applicable)	Each pile	IS:2911 & POWERGRID approved pile foundation drawings/specification	Joint inspection by POWER GRID and contractor	Verticality of the tube to be checked	B
iv)	Bentonite slurry (if applicable)	Each pile	IS:2911 & POWERGRID approved pile foundation drawings/specification	Joint inspection by POWER GRID and contractor	Records to be kept by POWERGRID for specific gravity of slurry	B
v)	Pile depth, level, size	Each pile	IS:2911 &	Joint	Approved by	B

POWERGRID CORPORATION OF INDIA LIMITED
(Quality Assurance & Inspection Deptt.)

	and alignment		POWERGRID approved pile foundation drawings/specification	inspection by POWER GRID and contractor	POWERGRID	
vi)	Chipping of pile head	Each pile	IS:2911 & POWERGRID approved pile foundation drawings/specification	Joint inspection by POWER GRID and contractor	Before concreting pile cap, pile head to be chipped off for concreting	B
vii)	Standard Penetrator Test	As per Powergrid BOQ/Specification	IS:2911 & POWERGRID approved pile foundation drawings/specification	Joint inspection by POWER GRID and contractor	Records to be kept by POWERGRID	B
viii)	Pile load testing	As per Powergrid BOQ/Specification IS:2911	IS:2911 & POWERGRID approved pile foundation drawings/specification	Joint inspection by POWER GRID and contractor	Records to be kept by POWERGRID Approval by POWERGRID	B
ix)	Anchor bolts if applicable					
a)	Level, centre to centre distance of bolts	100% on each location	POWERGRID approved pile foundation drawings/specification	Joint inspection by POWER GRID and contractor	Checklist to be prepared and signed jointly	B
b)	Visual check for galvanising	100% on each location	POWERGRID approved pile foundation drawings/specification	Joint inspection by POWER GRID and contractor	Checklist to be prepared and signed jointly	B
3.	CONCRETING					
A)	APPROVAL OF MIX DESIGN	Each Mix.	IS:456 & POWERGRID approved drawings and specifications	POWER GRID Approved by lab	Approval by POWERGRID	A
B)	BATCHING,MIX-	100%	IS:456 &	Joint	Approval by	B

POWERGRID CORPORATION OF INDIA LIMITED
(Quality Assurance & Inspection Deptt.)

	ING & PLACING OF CONCRETE AND COMPACTING		POWERGRID approved drawings and specifications	inspection by POWER GRID and contractor	POWERGRID	
C)	FIXING OF CHIMNEY COLUMN Check for Width/length squareness, parallelism & equidistance from stub	100%	IS:456 & POWERGRID approved drawings and specifications	Joint inspection by POWER GRID and contractor	Approval by POWERGRID	C
D)	PLACING CONCRETE, AND COMPACTING	100%	IS:456 & POWERGRID approved drawings and specifications	Joint inspection by POWER GRID and contractor	Min. gap between boxes and reinforcement bars should be maintained Approval by POWERGRID	B
E)	CONCRETE TESTING					
i)	Slump test	One sample per foundation	IS:456,IS:516, IS:1199 and POWERGRID Specification	Contractor	Approval by POWERGRID	B
ii)	Check for quantities for cement, fine aggregate, coarse aggregate and water while batching	100% on all locations	IS:456,IS:516, IS:1199 and POWERGRID Specification	Contractor	Checklist to be prepared and signed jointly	B

POWERGRID CORPORATION OF INDIA LIMITED
(Quality Assurance & Inspection Deptt.)

Sl. No.	Component/Operation & Description of Test	Sampling Plan with basis	Ref. Document & acceptance norm	Testing Agency	Remarks	Check
F)	CONCRETE CUBE TESTING					
i)	Compressive Strength	One sample for every 20 Cum of concreting or part thereof for each days concreting (one sample consists of min. 3 test cubes for 28 days strength).	IS:1199,IS:456, IS:516 and POWERGRID Specification	POWERGRID Approved lab	Approval by POWERGRID Cubes must be tested within a week after 28 days curing period and test results should be approved.	A
G)	CHECK FINISING, DIMENSIONAL CONFORMITY AND WORKMANSHIP BEFORE & AFTER BOX REMOVAL	100%	IS:456,IS:516, IS:1199 and POWERGRID Specification	Contractor	Approval by POWERGRID	B
4.	BACKFILLING					
i)	Check for thickness of Layer & watering	100%	POWERGRID Specification and approved drawings	Contractor	Approval by POWERGRID	C
ii)	Visual check for correction/ramming	100%	POWERGRID Specification and approved drawings	Contractor	Approval by POWERGRID	C
iii)	Compaction test (Percentage of max. dry density)	Gantry Foundation-2 samples for each pit. Equipment	POWERGRID specification	POWERGRID approved lab	Review of lab test results by POWERGRID Elevation for testing to be	B

POWERGRID CORPORATION OF INDIA LIMITED
(Quality Assurance & Inspection Deptt.)

		and other foundation- 20% at random			decided by POWERGRID	
5.	BRICK-WORK					
i)	Mortar mix/proportion	Random	IS:2250, POWERGRID Specification & CPWD Specification	Contractor	Approval by POWERGRID	B
ii)	Plumb & Alignment	Random	POWERGRID Specification & CPWD Specification	Contractor	Approval by POWERGRID	B
iii)	Joints	Random	POWERGRID Specification & CPWD Specification	Contractor	Approval by POWERGRID	B
6.	PLASTERING					
i)	Plastering thickness and evenness	Random	POWERGRID Specification & CPWD Specification	Contractor	Approval by POWERGRID	B
ii)	Mortar mix proportion	Random	POWERGRID Specification & CPWD Specification	Contractor	Approval by POWERGRID	B
7.	CURING FOR CONCRETE, MASONRY, PLASTERING ETC.	100% on all location	IS:5613 & POWERGRID Specification	Contractor	Approval by POWERGRID	C
8.	SWITCH YARD EARTHING					
i)	Check for dimension of earth mat rod	Random	POWERGRID Specification & drawings	Contractor	Approval by POWERGRID	B
ii)	Depth of excavation	Random	POWERGRID Specification & drawings	Contractor	Approval by POWERGRID	C
iii)	Check for weld joints and anti corrosive treatment	Random	POWERGRID Specification & drawings	Contractor	Approval by POWERGRID	B
iv)	Backfilling	100%	POWERGRID Specification & drawings	Contractor	Approval by POWERGRID	C
9.	SITE SURFACING					
i)	Levelling	100%	POWERGRID Specification and approved drawings	Contractor	Checklist to be prepared and signed jointly	C

POWERGRID CORPORATION OF INDIA LIMITED
(Quality Assurance & Inspection Deptt.)

ii) a)	Soil Sterilisation Spraying of chemicals	100%	POWERGRID Specification and Manufacturers recommendations	Con tractor	Checklist to be prepared and signed jointly	B
iii)	Grading of 20/40mm Stone	1 sample per lot of 500 Cubic Metre or part thereof from each source for each size	IS: 383, IS: 2386 and POWERGRID Specification. The grading shall be as per single sized nominal size	Contractor/ POWERGRID Approved lab	Each source to be approved by POWERGRID Review and acceptance of test results by POWERGRID	B
iv)	Compacted thickness of 20/40 mm stone layers as applicable	Random	POWERGRID Specification and specification drawings	Contractor	Checklist to be prepared and signed jointly	B

Section: GENERAL GUIDELINES FOR IMPLEMENTATION

1. Details of categories of check codes A,B & C including accepting and deviation dispositioning authorities are indicated at Annexure-I.
2. POWERGRID specification shall mean POWERGRID technical specification, approved drawings data sheets and LOA provisions applicable for the specific contract.
3. Acceptance criteria and permissible limits for certain tests are indicated at Annexure-II. For balance tests, site to verify the same with respect to POWERGRID specification, relevant Indian Standards and/or prevalent code of practice.
4. It is clarified that the tests indicated at column 2 of this FQP i.e. against column “Component operation & Description of Test”, are only generally required to be conducted. However, POWERGRID reserves the right to carry-out any additional tests at any stage if the situation so warrants.
5. POWERGRID site representative shall witness all the tests conducted by the contractor as mentioned in the FQP. However, in case of tests conducted in the POWERGRID approved lab, it is preferred to witness the tests in the lab itself, if possible.
6. Head of GHQ shall approve testing laboratory before accepting the test results from the lab.
7. Head of GHQ shall approve the sources for cement , coarse aggregate, fine aggregate & water before actual utilization.
8. All the testing & measuring equipments used by the contractor for testing are required to be calibrated. A copy of valid calibration report shall be retained by POWERGRID as records.
9. Classification of foundations shall be approved by POWERGRID based on the Joint Inspection Report & soil investigation reports.
10. Curing of concrete work should be continued for minimum period of 10 days.

POWERGRID CORPORATION OF INDIA LIMITED
(Quality Assurance & Inspection Deptt.)

11. ZONE-IV FINE AGGREGATE

- 11.1 Zone-IV fine aggregate shall be used for nominal mix. Reinforced cement concreting work.
- 11.2 Zone-IV fine aggregate shall be avoided for design mix reinforced cement concreting work unless tests have been done to ascertain the suitability of proposed with the prior approval POWERGRID site.

12. Bricks should be free from cracks, flaws and modules of free lime. They should have smooth rectangular faces with sharp corners and should be uniform in colour.

13. CEMENT

- 13.1 In case of cement is in the scope of the contractor, the same shall be procured from sources approved by POWERGRID site and got tested on sample basis for specified acceptance tests as specified in the FQP at a reputed Third Party Lab approved by POWERGRID site.
- 13.2 The samples of cement for site testing shall be taken within three weeks of the delivery and all the tests shall be commenced within one week of sampling. If the cement remains in store for a period of more than six months. All the site tests are required to be repeated before usage.

14. REINFORCEMENT STEEL & STRUCTURAL STEEL USED IN CABLE TRENCHES & FOUNDATIONS

- 14.1 In case supply of steel is in the scope of the contractor, the same shall be procured from the main producers i.e. SAIL, TISCO, IISCO or Rashtriya Ispat Nigam or the rerollers approved by main producers. The steel shall be got tested at site on sample basis for specified acceptance tests as specified in this FQP at a reputed Third Party Lab approved by POWERGRID site.
- 14.2 The results of the testing of cement and reinforcement steel referred in 13.1 and 14.1 above shall be got approved from POWERGRID site before cement and reinforcement steel are put to use. However, in exceptional cases due to exigencies of work. POWERGRID site may authorize the contractor to use Cement and Reinforcement Steel even before the test results are received. However, in all such cases, if the test results subsequently received are found to be not complying with the specified acceptance criteria, the contractor shall have to dismantle and recast all such foundations cast with such non-conforming materials at his own cost. Confirmation to this effect shall be obtained from the contractor by the Project authorities beforehand in all such cases.

15. The contractor shall submit welding procedure specification (WPS) including the type of electrode used for approval of POWERGRID site before starting the welding work.
16. Approval/acceptance of individual test results by POWERGRID in the course of execution of contract will not relieve the contractor of his contractual obligations and responsibilities, nor does it limit the Owner's right under the contract.
17. In case, requirement of special items like Super Sulphated Cement, Corrosive Resistant Reinforcement Steel (CRRS) etc. arise due to site conditions, the specific approval of POWERGRID may be obtained before using the same and all the tests as per relevant standards shall be carried out.
18. All the materials shall be stored by the contractor in a manner affording convenient access for identifications and inspection at all times. Storage of material shall be in accordance with IS: 4032 (Latest Edition).

POWERGRID CORPORATION OF INDIA LIMITED
(Quality Assurance & Inspection Deptt.)

ANNEXURE-I

PAGE 1 OF 1

**ACCEPTING AND DEVIATION DISPOSITIONG AUTHORITIES FOR DIFFERENT
CATEGORIES OF CHECKS AS ENVISAGED IN FIELD QUALITY PLANT**

CATE GORY	TYPE OF CHECK	100% CHECKING/WITNESSING BY	COUNTER CHECK/SURVEI LLANCE CHECK BY	ACCEPTING AUTHORITY, IF TEST RESULTS ARE WITHIN PERMISSIBLE LIMITS	DEVIATION DISPOSITIONING AUTHORITY
'A'	CRITI- CAL	EXECUTING DEPTT. PLUS FQA REPRESENTATIVE GHQ	FQA REPRESENTATIVE AND RHQ/DHQ REPRESENTATIVE	HEAD OF DHQ	HEAD OF RHQ IN CONSULTATION WITH CQA, IF REQUIRED.
'B'	MAJOR	EXECUTING DEPTT.	DHQ- REPRESENTATIVE	HEAD OF GHQ	HEAD OF DHQ
'C'	MINOR	CONTRACTORS REPRESENTATIVE	EXECUTING DEPTT.	MINIMUM E4 LEVEL EXECUTING OF SUB- STATION/TL	HEAD OF GHQ

POWERGRID CORPORATION OF INDIA LIMITED
(Quality Assurance & Inspection Deptt.)

ANNEXURE-2
Page 1 of 5

**ACCEPTANCE CRITERIA AND PERMISSIBLE LIMITS FOR
FOUNDATION MATERIALS AND CONCRETE**

A) CEMENT

S. No.	Description of the tests	33 Grade OPC as per IS:269	43 Grade cement as per IS:8112	PPC as per IS:1489	Low Heat cement
1.	Fineness (min.)	225 m ² /kg	225 m ² /kg	300 m ² /kg	225 m ² /kg
2.	Compressive strength (min.) 72 ± 1 hours 168 ± 2 hours 672 ± 4 hours	160 kgf/cm ² 220 kgf/cm ² -	23 MPa 33 MPa 43 MPa	16 MPa 22 MPa 33 MPa	100 Kgf/cm ² 160 Kgf/cm ² 350 Kgf/cm ²
3.	Initial setting time (min.)	30 minutes	30 minutes.	30 minutes	30 minutes
4.	Final setting time (max.)	600 minutes	600 minutes	600 minutes.	600 minutes.
5.	Soundness (Le Chatelier Method)	Maximum 10 mm expansion	Maximum 10 mm expansion	Maximum 10 mm expansion	Maximum 10 mm expansion
6.	Heat of Hydration (max.)	-	-	-	Max. 65 cal/gm for 7 days & max. 75 cal./gm for 28 days
7.	Chemical composition	As per IS	As per IS	As per IS	As per IS

B) COARSE AGGREGATE :

(i) Sieve Analysis

IS SIEVE DESIGNATION	PERCENTAGE PASSING FOR GRADED AGGREGATE OF NOMINAL SIZE		PERCENTAGE PASSING FOR SINGLE SIZED AGGREGATE OF NOMINAL SIZE	
	40 mm	20 mm	40 mm	20 mm
63 mm	-	-	100	-
40 mm	95 to 100	100	85 – 100	100
20 mm	30 to 70	95 to 100	0 – 20	85 - 100
10 mm	10 to 35	25 to 55	0 – 5	0 - 20
4.75 mm	0 to 5	0 to 10	-	0 - 5

POWERGRID CORPORATION OF INDIA LIMITED
(Quality Assurance & Inspection Deptt.)

ANNEXURE-2
Page 2 of 5

- (ii) Flakiness Index Not to exceed 25%
- (iii) Crushing value Not to exceed 45%
- (iv) Soundness of aggregate applicable for concrete works subject to frost action Loss of weight after 5 cycle not to exceed 12% when tested with Sodium sulphate and 18% when tested with magnesium sulphate
- (v) Deleterious material Not to exceed 5% of the weight of aggregate when tested as per IS:2386 Part – II (1963)

(C) FINE AGGREGATE

- (i) Sieve Analysis Shall confirm to Zone-I, Zone-II or Zone-III

IS Sieve designation	Grading Zone-I	Percentage Grading Zone-II	Passing for Grading Zone-III	Grading Zone-IV
10 mm	100	100	100	100
4.75 mm	90 - 100	90 - 100	90 - 100	90 - 100
2.36 mm	60 - 95	75 - 100	85 - 100	95 - 100
1.18 mm	30 - 70	55 - 90	75 - 100	90 - 100
600 Micron	15 - 34	35 - 59	60 - 79	80 - 100
300 Micron	15 - 20	8 - 30	12 - 40	15 - 50
150 Micron	0 - 10	0 - 10	0 - 10	0 - 15

- (ii) For guidance of adjusting sound in mix of concrete, the following table may be used.

Moisture Content %	building % by volume
2	15
3	20
4	25
5	30

- (iii) Silt Content Test: Shall not exceed 8% when tested as per test procedure specified in appendix-D of chapter 3 of 1991-92 CPWD Specification.
- (iv) Deleterious Materials: Total deleterious material shall not be more than 5% by weight.

POWERGRID CORPORATION OF INDIA LIMITED
(Quality Assurance & Inspection Deptt.)

ANNEXURE-2
Page 3 of 5

(D) REINFORCEMENT STEEL: As per relevant Indian Standards.

(E) CONCRETE CUBE TEST

For nominal (volumetric) concrete mixes, compressive strength for 1:1¹/₂:3 (cement : sand : coarse aggregate) concrete shall be 265 kg/cm² for 28 days and for 1:2:4 nominal mix, it shall be 210Kg/cm².

(F) ACCEPTANCE CRITERIA BASED ON 28 DAYS COMPRESSIVE STRENGTH FOR NOMINAL MIX CONCRETE

- (a) The average of the strength of three specimen be accepted as the compressive strength of the concrete, provided the strength of any individual cube shall neither be less than 70% nor higher than 130% of the specified strength.
- (b) If the actual average strength of accepted sample exceeds specified strength by more than 30%, the Engineer-in-charge, if he so desires, may further investigate the matter. However, if the strength of any individual cube exceeds more than 30% of specified strength, it will be restricted to 30% only for computation of strength.
- (c) If the actual average strength of accepted sample is equal to or higher than specified strength upto 30%, then strength of the concrete shall be considered in order and the concrete shall be accepted at full rates.
- (d) If the actual average strength of accepted sample is less than specified strength but not less than 70% of the specified strength, the concrete may be accepted at reduced rate at the discretion of Engineer-in-Charge.
- (e) If the actual average strength of accepted sample is less than 70% of specified strength, the Engineer-in-Charge shall reject the defective portion of work represented by sample and nothing shall be paid for the rejected work. Remedial measures necessary to retain the structure shall be taken at the risk and cost of contract. If, however, the Engineer-in-Charge so desires, he may order additional tests to be carried out to ascertain if the structure can be retained. All the charges in connection with these additional tests shall be borne by the contractor.

(G) ACCEPTANCE CRITERIA FOR DESIGN MIX CONCRETE SHALL BE AS PER IS:456.

POWERGRID CORPORATION OF INDIA LIMITED
(Quality Assurance & Inspection Deptt.)

ANNEXURE-2
Page 4 of 5

(H) SAMPLING PLAN FOR BRICK WORK

- i) Scale of sampling and permissible number of defectives for visual and dimensional characteristics.

No. of bricks in the lot	For characteristics specified for individual bricks		For dimensional characteristics for group of 20 bricks-No. of bricks to be selected
	No. of bricks to be selected	Permissible no. of defective in the sample	
(1)	(2)	(3)	(4)
2001-10000	20	1	40
10001-35000	32	2	60
35001-50000	50	3	80

Note : In case the lot contains 2000 or less bricks the sampling shall be as per decision of the Engineer-in-Charge.

- ii) Scale of sampling for physical characteristics

Lot size	Sampling size for compressive strength water absorption and efflorescence	Permissible no of defectives for effloresnce
(1)	(2)	(3)
2001-10000	5	0
10001-35000	10	0
35001-50000	15	1

Note: In case the lot contains 2000 or less bricks, the sampling shall be as per decision of Engineer-in-Charge.

POWERGRID CORPORATION OF INDIA LIMITED
(Quality Assurance & Inspection Deptt.)

ANNEXURE-2
Page 5 of 5

(I) ACCEPTANCE CRITERIA FOR BRICK-WORK

- (i) Dimensional tolerances: The dimensions of modular bricks when tested shall be within the following limits per 20 bricks.

Length 372 to 388 cm (380 ± 8 cm)

Width 176 to 184 cm ($180 \pm$ cm)

Height 176 to 184 cm (180 ± 4 cm) for 90 mm high bricks

- (ii) In case of non-modular bricks, %age tolerance will be +/- 2% for group of 20 numbers of class 10 bricks and +/- 4% for other class of bricks.

- (iii) Compressive strength: The bricks, shall have a minimum average compressive strength as specified in POWERGRID specification. The compressive strength of any individual brick tested shall not fall below the min. average compressive strength specified for the corresponding class of brick by more than 20%. In case compressive strength of any individual brick tested exceeds the upper limit specified for the corresponding class of bricks, the same shall be limited to upper limit of the class as specified for the purpose of calculating the average compressive strength.

- (iv) Water absorption: The average water absorption of bricks shall not be more than 20% by weight.

- (v) Efflorescence: The rating of efflorescence of bricks shall not be more than moderate.

765/400kV SUBSTATION AT RAICHUR

LIST OF DRAWINGS

S. No.	DRAWING NO.	TITLE
1.	C/ENGG/STD/CT/01	Details of Cable Trench Sections
2.	C/ENGG/STD/CT/02	Details of Cable Trench Sections
3.	C/ENGG/STD/CT/03	RCC details of Cable Trench Sections
4.	C/ENGG/STD/CT/04	GA & RCC details of Sump pit
5.	C/ENGG/STD/CT/05	Detail of cable trench crossing
6.	C/ENGG/STD/TOW/7CA/765/FDN/01	Foundation Details of 765 Kv Tower marked "7CA"
7.	C/ENGG/STD/TOW/7CA/765/FDN/02	Foundation Details of 765 Kv Tower marked "7CB"
8.	C/ENGG/STD/TOW/7CA/765/FDN/03	Foundation Details of 765 Kv Tower marked "7CC"
9.	C/ENGG/STD/TOW/7CA/765/FDN/04	Foundation Details of 765 Kv Tower marked "7CD"
10.	C/ENGG/STD/TOW/7CA/765/FDN/05	Foundation Details of 765 Kv Tower marked "7CE"
11.	C/ENGG/STD/TOW/400/FDN/01	Foundation details of 400 Kv Towers
12.	C/ENGG/STD/TOW/400/FDN/01A	Foundation details of 400 Kv Towers
13.	C/ENGG/STD/TOW/400/FDN/01B	Foundation details of 400 Kv Towers
14.	C/ENGG/STD/TOW/400/FDN/01C	Foundation details of 400 Kv Towers
15.	C/ENGG/STD/EQP/765/FDN/06(Sheet 1 of 2)	Foundation details of 765 Kv Equipments
16.	C/ENGG/STD/EQP/765/FDN/06(Sheet 2 of 2)	Foundation details of 765 Kv Equipments
17.	C/ENGG/STD/EQP/400/FDN/01	Foundation details of 400 Kv Equipment
18.	C/ENGG/STD/EQP/FDN/03	Details of CB foundations
19.	C/ENGG/STD/EQP/FDN/04	Details of wave trap foundation

General Notes

1. ALL DIMENSIONS ARE IN MM. UNLESS NOTED OTHERWISE.
2. DO NOT SCALE THE DRAWING, ONLY WRITTEN DIMENSIONS TO BE FOLLOWED.
3. LAP LENGTH SHALL BE 47 TIMES DIA OF BAR.
4. PROVIDE CLEAR COVER TO REINFORCING UNDER.
 - 25mm FOR TOP SIDE OF BOTTOM SLAB
 - 50mm FOR OUTER SIDE OF WALL
5. ALL R.C.C SHALL BE OF GRADE M25 UNLESS NOTED OTHERWISE.
6. LIFTING HOOK SHALL BE PROVIDED IN EVERY REINFORCING COVER SLAB.
7. NECESSARY OPENINGS SHALL BE PROVIDED AT APPROPRIATE LOCATIONS TO TAKE OUT CABLES.
8. FOR ACTUAL DEPTH OF TRENCHES REFER APPROVED CABLE TRENCH LAYOUT.
9. F.G.L. DENOTES FINISHED GROUND LEVEL.
10. ALL CABLE TRENCHES SHALL HAVE A SLOPE OF 1:1000 IN THE DIRECTION OF MAIN RUN AWAY FROM THE BUILDING.
11. EARTHING CONDUCTOR 'E' 50x6 M.S. FLAT SHALL BE WELDED TO THE CABLE SUPPORTING STRUCTURE BEFORE INSTALLATION OF CABLE.
12. ALL STEEL STRUCTURES PLATES SHALL BE PAINTED WITH ANTI-CORROSION PAINT OVER A COAT OF SUITABLE PRIMER BEFORE INSTALLATION OF CABLES; EARTHING CONDUCTOR SHALL BE PAINTED RED.
13. CONSTRUCTION JOINT SHALL BE PROVIDED AT 30M OR AS PER SITE REQUIREMENT BUT NOT EXCEEDING 30M.
14. ALL SUPPORT ANGLES SHALL BE 50x50x6.
15. ANCHORING FLAT (75x6) SHALL BE PROVIDED AT EACH SUPPORT ANGLE POINT.
16. EARTHING CONDUCTOR 'E' SHALL BE PROVIDED ON THE TOP TIER OF EACH CABLE TRENCH SECTION.
17. IN CASE EXPANSIVE SOIL IS ENCOUNTERED AT FOUNDING LEVEL, IT SHALL BE REMOVED TO A MINIMUM DEPTH OF 300 MM AND SHALL BE REPLACED BY WELL COMPACTED LOCALLY AVAILABLE C.N.S. MATERIAL.
18. ALL REINFORCEMENT STEEL BARS (Ø) SHALL CONFORM TO IS:1786-1985 OF GRADE Fe500

1.	RO	03/02/2012
No.	Revision/Issue	Date

POWER GRID CORPORATION OF INDIA LIMITED
(A Government of India Enterprise)

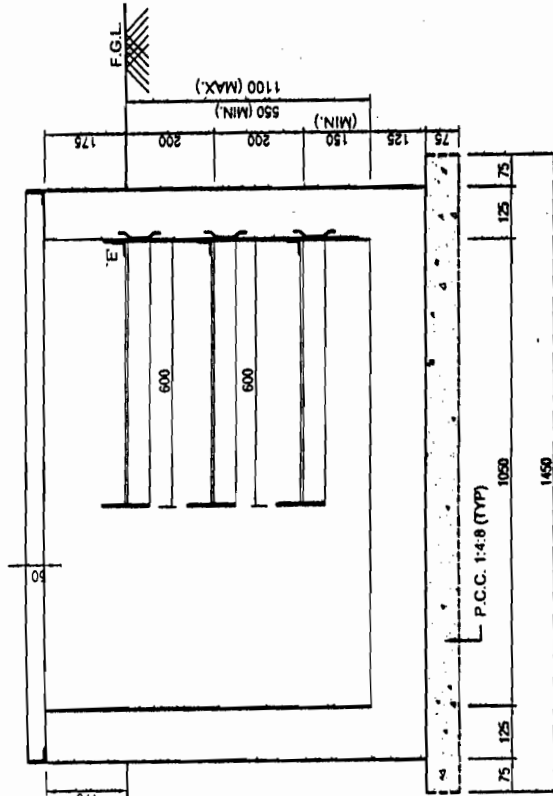

SECTION 2-2

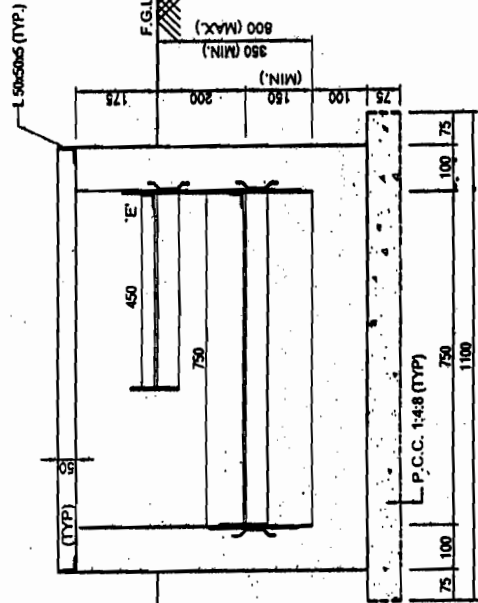

SECTION 3-3

50x50x6 CLEAT TO BE WELDED

EARTHING CONDUCTOR 'E' (50x6 M.S. FLAT)

L50x50x6

75x6 M.S. FLAT INS.P
CABLE TRENCH WALL

CAL CABLE SUPPORT

BHEL RELEASED FOR PRODUCTION

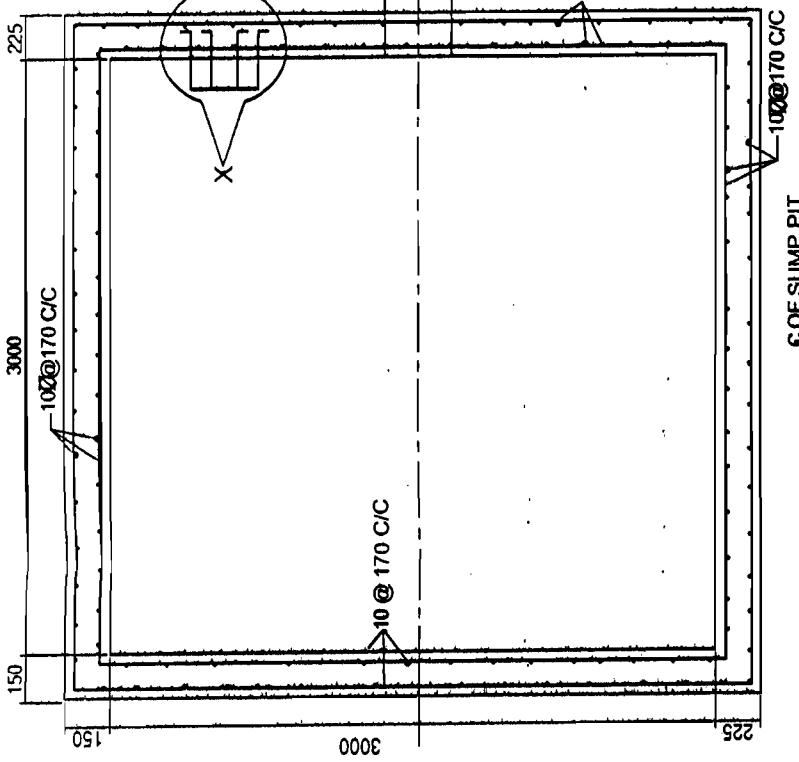

5 NOS. PRECAST R.C.C. COVER SLAB 3450X400X50 THK

PRECAST R.C.C. COVER SLAB 975X400X50



BHEL RELEASED FOR CONSTRUCTION
DESTROY EARLIER PERMITTED RED.
 SIGNED: DATE:
 Transmission Project
 Engineering Management

SECTION 3-3

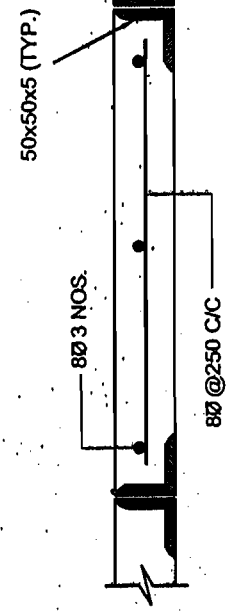
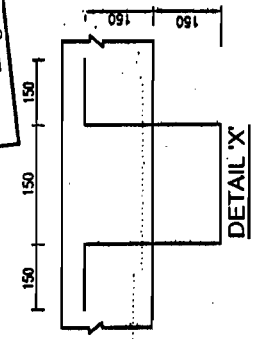

SECTION E-E

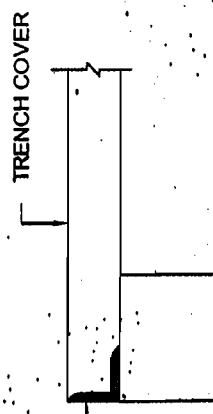

General Notes	
1.	ALL DIMENSIONS ARE IN MM. UNLESS NOTED OTHERWISE.
2.	DO NOT SCALE THE DRAWING, ONLY WRITTEN DIMENSIONS TO BE FOLLOWED.
3.	LAP LENGTH SHALL BE 47 TIMES DIA OF BAR.
4.	PROVIDE CLEAR COVER TO REINFORCING BARS UNDER: • 25mm FOR TOP SIDE OF BOTTOM SLAB. • 50mm FOR OUTER SIDE OF WALL. NOTED OTHERWISE.
5.	ALL R.C.C SHALL BE OF GRADE M25 UNLESS NOTED OTHERWISE.
6.	LIFTING HOOK SHALL BE PROVIDED IN EVERY TENTH COVER SLAB.
7.	NECESSARY OPENINGS SHALL BE PROVIDED AT APPROPRIATE LOCATIONS TO TAKE OUT CABLES.
8.	FOR ACTUAL DEPTH OF TRENCHES REFER APPROVED CABLE TRENCH LAYOUT.
9.	F.G.L. DENOTES FINISHED GROUND LEVEL.
10.	ALL CABLE TRENCHES SHALL HAVE A SLOPE OF 1:1000 IN THE DIRECTION OF MAIN RUN AWAY FROM THE BUILDING.
11.	EARTHING CONDUCTOR 'E' 50x6 M.S. FLAT SHALL BE WELDED TO THE CABLE SUPPORTING STRUCTURE BEFORE INSTALLATION OF CABLE.
12.	ALL STEEL STRUCTURES PLATES SHALL BE PAINTED WITH ANTI-CORROSIVE PAINT OVER A COAT OF SUITABLE PRIMER BEFORE INSTALLATION OF CABLES. EARTHING CONDUCTOR SHALL BE GALVANIZED OR PAINTED RED.
13.	CONSTRUCTION JOINT SHALL BE PROVIDED AT 10M INTERVALS PER SITE REQUIREMENT BUT NOT EXCEEDING 50M.
14.	ALL SUPPORT ANGLE SHALL BE 50x50x6 ANCHORING FLAT (75x6) SHALL BE PROVIDED AT EACH SUPPORT ANGLE POINT.
15.	EARTHING CONDUCTOR 'E' SHALL BE PROVIDED ON THE TOP TIER OF EACH CABLE TRENCH SECTION.
16.	IF EXPANSIVE SOIL IS ENCOUNTERED AT FOUNDING LEVEL, IT SHALL BE REMOVED TO A MINIMUM DEPTH OF 300 MM AND SHALL BE REPLACED BY WELL COMPACTED LOCALLY AVAILABLE C.N.S. MATERIAL.
17.	ALL REINFORCEMENT STEEL BARS (Ø) SHALL CONFORM TO IS:1786-1985 OF GRADE Fe500

1.	RO	03/02/2012
No.	Revision/Issue	Date
POWER GRID CORPORATION		

General Notes

1. ALL DIMENSIONS ARE IN MM UNLESS NOTED OTHERWISE
2. DO NOT SCALE THE DRAWING, ONLY WRITTEN DIMENSIONS TO BE FOLLOWED
3. F.G.L DENOTES FINISHED GROUND LEVEL
4. CLASS 75 BRICKS SHALL BE USED
5. CONCRETE MIX FOR COVERING RCC PIPE SHALL BE 1:2:4 (1 CEMENT; 2 COARSE SAND; 4 COARSE AGGREGATE)
6. RCC HUMME PIPE SHALL BE OF GRADE NP3
7. ALL LEAN CONCRETE SHALL BE OF GRADE 1:4:8 (1 CEMENT; 4 COARSE SAND; 8 COARSE AGGREGATE)
8. BRICK MASONRY SHALL BE DONE USING CEMENT MORTAR 1:6 (1 CEMENT; 6 FINE SAND)

BHEL RELEASED
 FOR
 CONSTRUCTION
 DESTROY EARLIER PRINTS
 SIGNED: M. MAHAJAN DATE: 17/11/12
 Transmission Projects
 Engineering Management

No.	RO	03/02/2012
No.	Revision/Issue	Date

POWER GRID CORPORATION

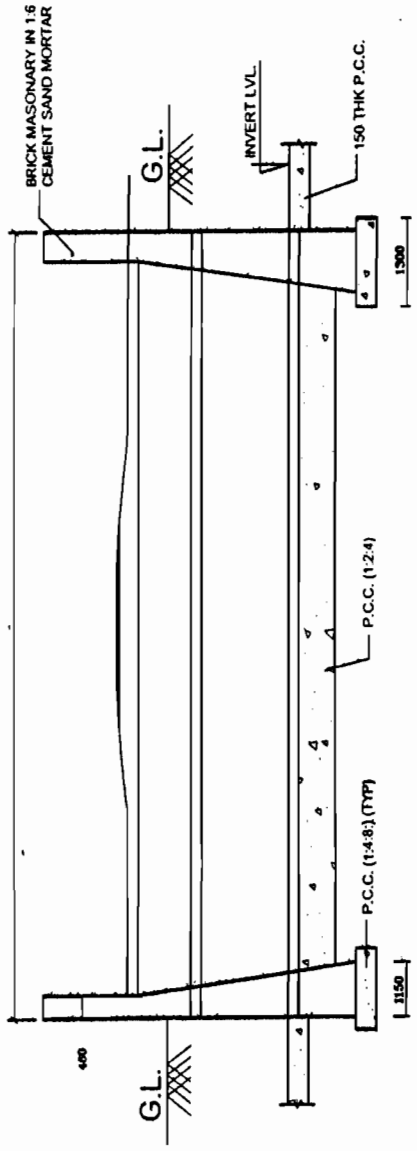

LONGITUDINAL SECTION THROUGH CABLE TRENCH CROSSING ROAD

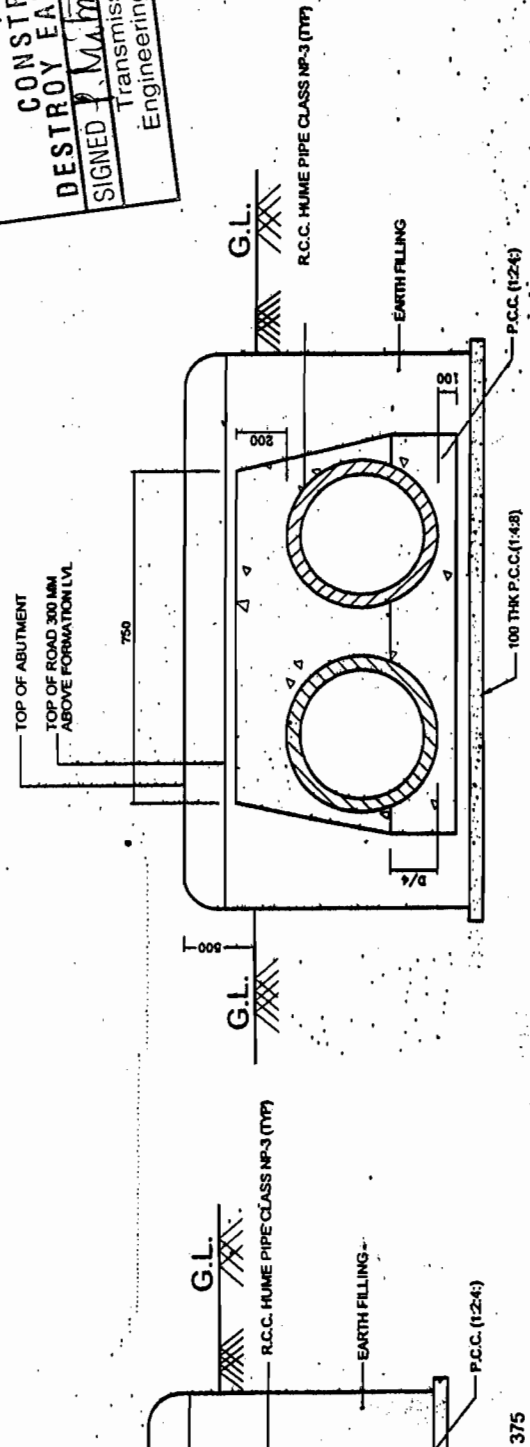

General Notes

1. ALL DIMENSIONS ARE IN MM. UNLESS NOTED OTHERWISE.
2. DO NOT SCALE THE DRAWING. ONLY WRITTEN DIMENSIONS TO BE FOLLOWED.
3. LAP LENGTH SHALL BE 47 TIMES DIA OF BAR.
4. PROVIDE CLEAR COVER TO REINF AS UNDER.
 - 25mm FOR TOP SIDE OF BOTTOM SLAB.
 - 50mm FOR OUTER SIDE OF WALL.
5. ALL R.C.C SHALL BE OF GRADE M25 UNLESS NOTED OTHERWISE.
6. LIFTING HOOK SHALL BE PROVIDED IN EVERY TENTH COVER SLAB.
7. NECESSARY OPENINGS SHALL BE PROVIDED AT APPROPRIATE LOCATIONS TO TAKE OUT CABLES.
8. FOR ACTUAL DEPTH OF TRENCHES REFER APPROVED CABLE TRENCH LAYOUT.
9. F.G.L. DENOTES FINISHED GROUND LEVEL.
10. ALL CABLE TRENCHES SHALL HAVE A SLOPE OF 1:1000 IN THE DIRECTION OF MAIN RUN AWAY FROM THE BUILDING.
11. EARTHING CONDUCTOR 'E' 50x6 M.S. FLAT SHALL BE WELDED TO THE CABLE SUPPORTING STRUCTURE BEFORE INSTALLATION OF CABLE.
12. ALL STEEL STRUCTURES PLATES SHALL BE PAINTED WITH ANTI-CORROSIVE PAINT OVER A COAT OF SUITABLE PRIMER BEFORE INSTALLATION OF CABLES. EARTHING CONDUCTOR SHALL BE PAINTED RED.
13. CONSTRUCTION JOINT SHALL BE PROVIDED AT 30M OR AS PER SITE REQUIREMENT BUT NOT EXCEEDING 30M.
14. ALL SUPPORT ANGLES SHALL BE 50x50x6.
15. ANCHORING FLAT (75x6) SHALL BE PROVIDED AT EACH SUPPORT ANGLE POINT.
16. EARTHING CONDUCTOR 'E' SHALL BE PROVIDED ON THE TOP TER OF EACH CABLE TRENCH SECTION.
17. IN CASE EXPANSIVE SOIL IS ENCOUNTERED AT FOUNDING LEVEL, IT SHALL BE REMOVED TO A MINIMUM DEPTH OF 300 MM AND SHALL BE REPLACED BY WELL COMPACTED LOCALLY AVAILABLE C.N.S. MATERIAL.
18. ALL REINFORCEMENT STEEL BARS (Φ) SHALL CONFORM TO IS:1786-1985 OF GRADE Fe500.

No.	Revision/Issue	Date
1.	RO	03/02/2012

POWER GRID CORPORATION OF INDIA LIMITED

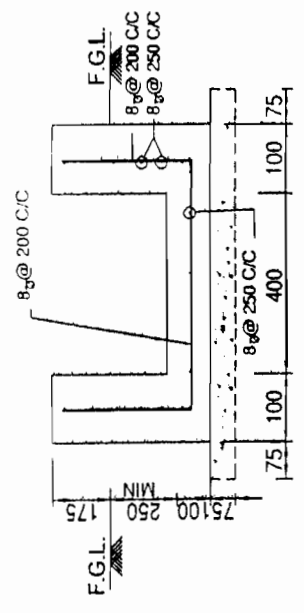

SECTION 4-4

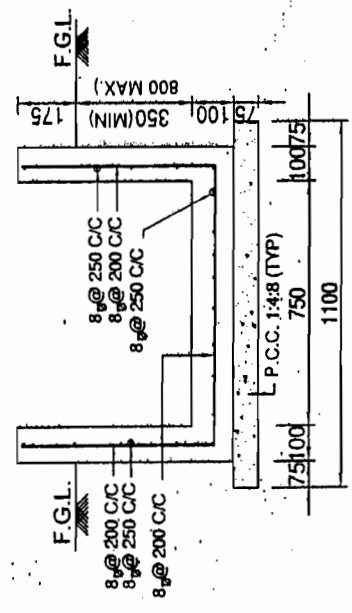

SECTION 3-3

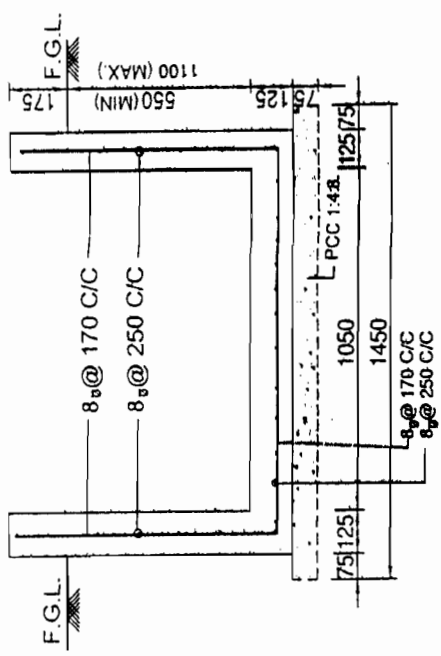

SECTION 2-2

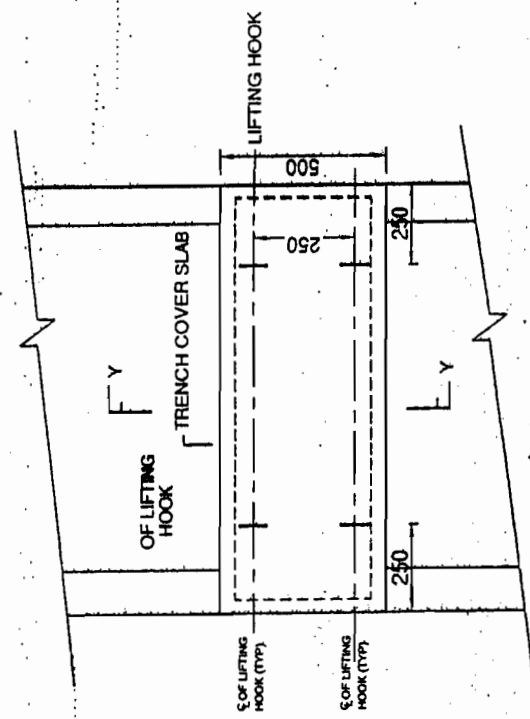

(DETAIL OF TRENCH COVER FOR SECTION 3-3 & 4-4)

BHEL RELEASED FOR CONSTRUCTION PRINTS

General Notes

1. ALL DIMENSIONS ARE IN MM UNLESS NOTED OTHERWISE.
2. DO NOT SCALE THE DRAWING, ONLY WRITTEN DIMENSIONS TO BE FOLLOWED.
3. LAP LENGTH SHALL BE 47 TIMES DIA OF BAR.
4. PROVIDE CLEAR COVER TO REINFORCING UNDER.
 - 25mm FOR TOP SIDE OF BOTTOM SLAB.
 - 50mm FOR OUTER SIDE OF WALL
5. ALL R.C.C SHALL BE OF GRADE M25 UNLESS NOTED OTHERWISE.
6. LIFTING HOOK SHALL BE PROVIDED IN EVERY TENTH COVER SLAB.
7. NECESSARY OPENINGS SHALL BE PROVIDED AT APPROPRIATE LOCATIONS TO TAKE OUT CABLES.
8. FOR ACTUAL DEPTH OF TRENCHES REFER APPROVED CABLE TRENCH LAYOUT
9. F.G.L DENOTES FINISHED GROUND LEVEL
10. ALL CABLE TRENCHES SHALL HAVE A SLOPE OF 1:1000 IN THE DIRECTION OF MAIN RUN AWAY FROM THE BUILDING.
11. EARTHING CONDUCTOR ∇ 50x6 M.S. FLAT SHALL BE WELDED TO THE CABLE SUPPORTING STRUCTURE BEFORE INSTALLATION OF CABLE
12. ALL STEEL STRUCTURES PLATES SHALL BE PAINTED WITH ANTI-CORROSIVE PAINT OVER A COAT OF SUITABLE PRIMER BEFORE INSTALLATION OF CABLES. EARTHING CONDUCTOR SHALL BE PAINTED RED.
13. CONSTRUCTION JOINT SHALL BE PROVIDED AT 30M OR AS PER SITE REQUIREMENT BUT NOT EXCEEDING 30M.
14. ALL SUPPORT ANGLES SHALL BE 50x50x6
15. ANCHORING FLAT (75x6) SHALL BE PROVIDED AT EACH SUPPORT ANGLE POINT.
16. EARTHING CONDUCTOR ∇ SHALL BE PROVIDED ON THE TOP TIER OF EACH CABLE TRENCH SECTION.
17. IN CASE EXPANSIVE SOIL IS ENCOUNTERED AT FOUNDING LEVEL, IT SHALL BE REMOVED TO A MINIMUM DEPTH OF 300 MM AND SHALL BE REPLACED BY WELL COMPACTED LOCALLY AVAILABLE C.N.S. MATERIAL
18. ALL REINFORCEMENT STEEL BARS (∇) SHALL CONFORM TO IS:1786-1985 OF GRADE Fe500

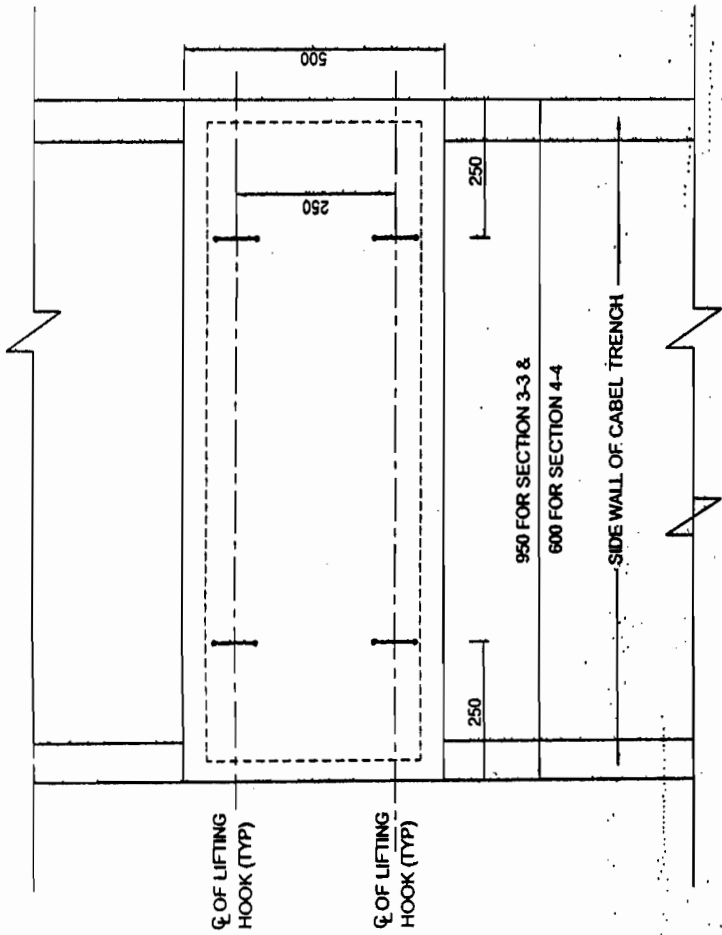

DETAIL OF TRENCH COVER SLAB FOR SECTION (3-3) & (4-4)

BHEL RELEASED FOR CONSTRUCTION PRINTS
DESTROY EARLIER PRINTS
 SIGNED: *[Signature]* DATE: 23/02/2012
 Transmission Projects
 Engineering Management
 No. 1. RO 03/02/2012
 Revision/Issue Date
 POWER GRID CORPORATION

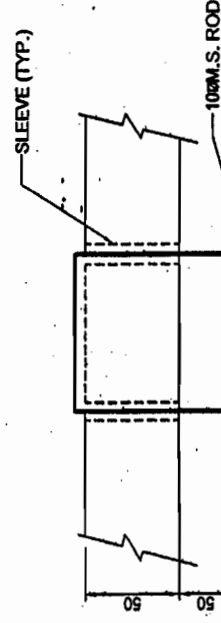

General Notes

1. FOR DETAILS OF FDN. BOLTS REFER APPROVED STRUCTURE DRAWING.
 2. IN THIS DRAWING: ϕ DENOTES REINF. STEEL CONFORMING TO I.S.1786 - 1985 OF GRADE Fe 500
 3. LAP LENGTH SHALL BE 47 TIMES DIA OF BAR.
 4. PROVIDE CLEAR COVER TO REINF. AS UNDER.
 - * 50mm FOR BOTTOM, TOP & SIDE REINFORCEMENT OF RAFT.
 - * 50mm FOR COLUMN.
 5. ALL DIMENSIONS ARE IN MM UNLESS OTHERWISE NOTED
 6. DO NOT SCALE THE DRAWING. ONLY WRITTEN DIMENSIONS SHALL BE FOLLOWED.
 7. UNLESS OTHERWISE NOTED ALL CONCRETE SHALL BE OF GRADE M-25
 8. FOR ORIENTATION OF FOUNDATION REFER APPROVED FDN. LAYOUT
 9. FINAL EXCAVATION LEVEL SHALL BE MIN. 1000mm BELOW NGL.
 10. IF EXPANSIVE SOIL IS ENCOUNTERED AT FOUNDING LVL. NECESSARY TREATMENT OF SOIL SHALL BE DONE AS PER RECOMMENDATIONS OF SOIL REPORT BEFORE PLACING THE FOUNDATION.
 11. THIS DRAWING IS APPLICABLE FOR SBC OF 10T/SqM OR ABOVE
- IMP: - LOCATION OF FDN. BOLTS SHALL BE VERIFIED FROM APPROVED STR. DRAWING BEFORE EMBEDDMENT

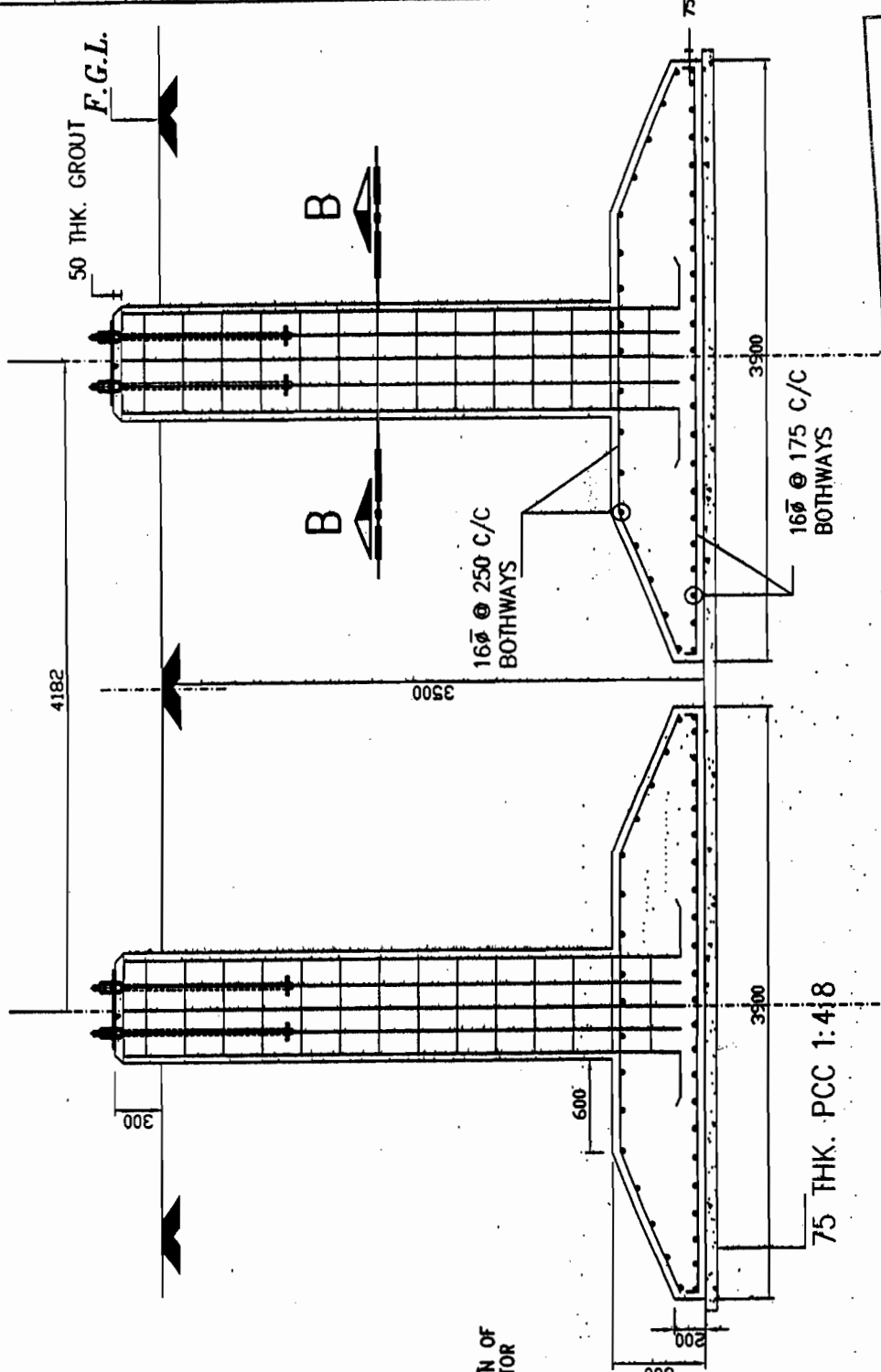

BHEL RELEASED FOR CONSTRUCTION FOR EARLIER PRINTS
 SIGNED: *M. V. M.* DATE: 22/5/12
 Transmission Projects Engineering Management

SECTION A-A

VERT. REINF. 16 NOS 28 ϕ

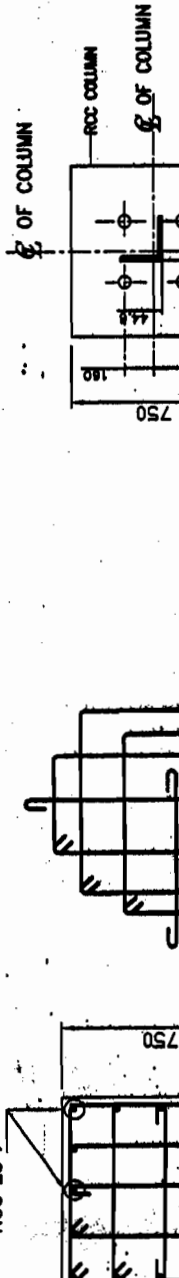

1.	RO	26/12/2011
No.	Revision/Issue	Date
POWER GRID CORPORATION		

General Notes

1. FOR DETAILS OF FDN. BOLTS REFER APPROVED STRUCTURE DRAWING.
2. IN THIS DRAWING ϕ DENOTES REINF. STEEL CONFORMING TO I.S.1786 - 1985 OF GRADE Fe 500
3. LAP LENGTH SHALL BE 47 TIMES DIA OF BAR.
4. PROVIDE CLEAR COVER TO REINF. AS UNDER.
 - * 50mm FOR BOTTOM, TOP & SIDE REINFORCEMENT OF RAFT.
 - * 50mm FOR COLUMN.
5. ALL DIMENSIONS ARE IN MM UNLESS OTHERWISE NOTED
6. DO NOT SCALE THE DRAWING. ONLY WRITTEN DIMENSIONS SHALL BE FOLLOWED.
7. UNLESS OTHERWISE NOTED ALL CONCRETE SHALL BE OF GRADE M-25
8. FOR ORIENTATION OF FOUNDATION REFER APPROVED FDN. LAYOUT
9. FINAL EXCAVATION LEVEL SHALL BE MIN. 1000mm BELOW NGL
10. IF EXPANSIVE SOIL IS ENCOUNTERED AT FOUNDING LVL. NECESSARY TREATMENT OF SOIL SHALL BE DONE AS PER RECOMMENDATIONS OF SOIL REPORT BEFORE PLACING THE FOUNDATION.
11. THIS DRAWING IS APPLICABLE FOR SBC OF 10T/Sq.M OR ABOVE

IMP: - LOCATION OF FDN. BOLTS SHALL BE VERIFIED FROM APPROVED STR. DRAWING BEFORE EMBEDDMENT

No.	Revision/Issue	Date
1.	RO	26/12/2011

POWER GRID CORPORATION OF INDIA LIMITED

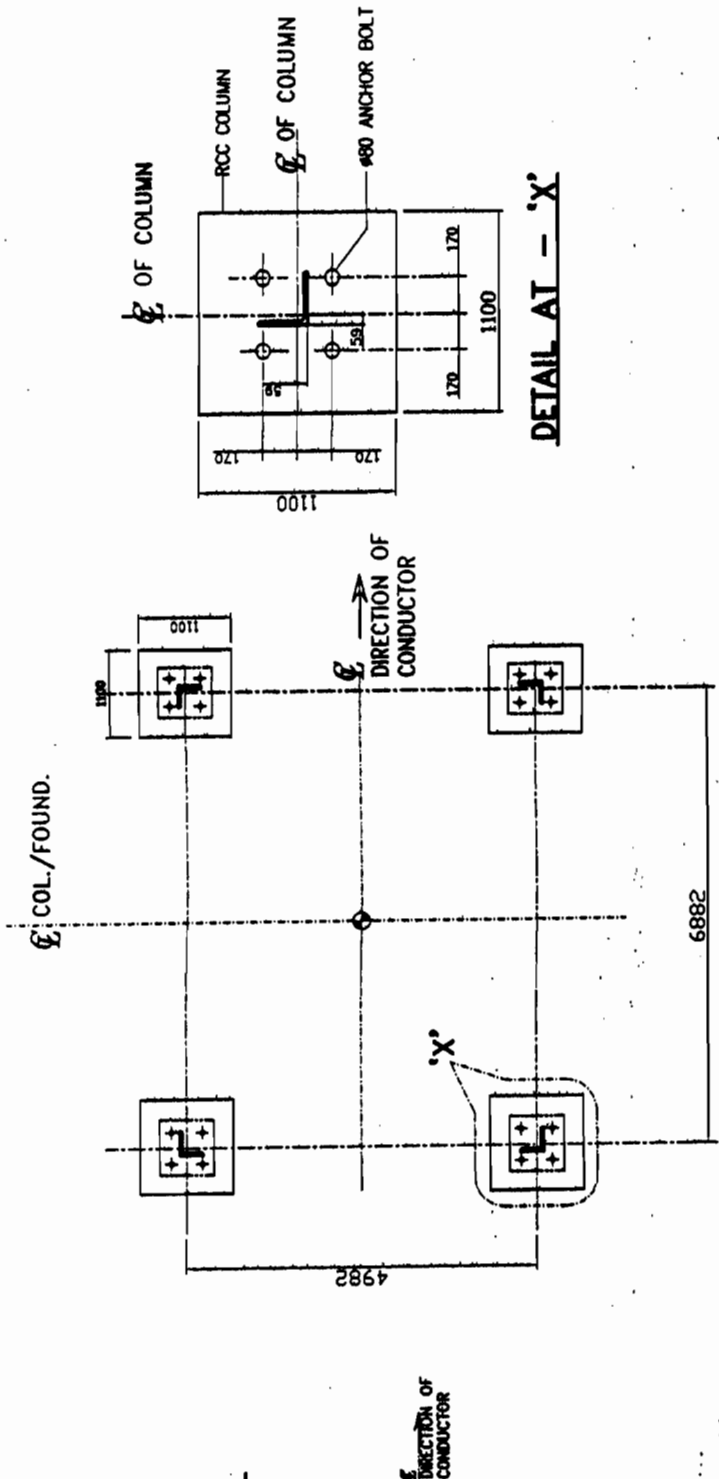

DETAIL AT - 'X'

TYP. ANCHOR BOLT SETTING PLAN FOR TOWER

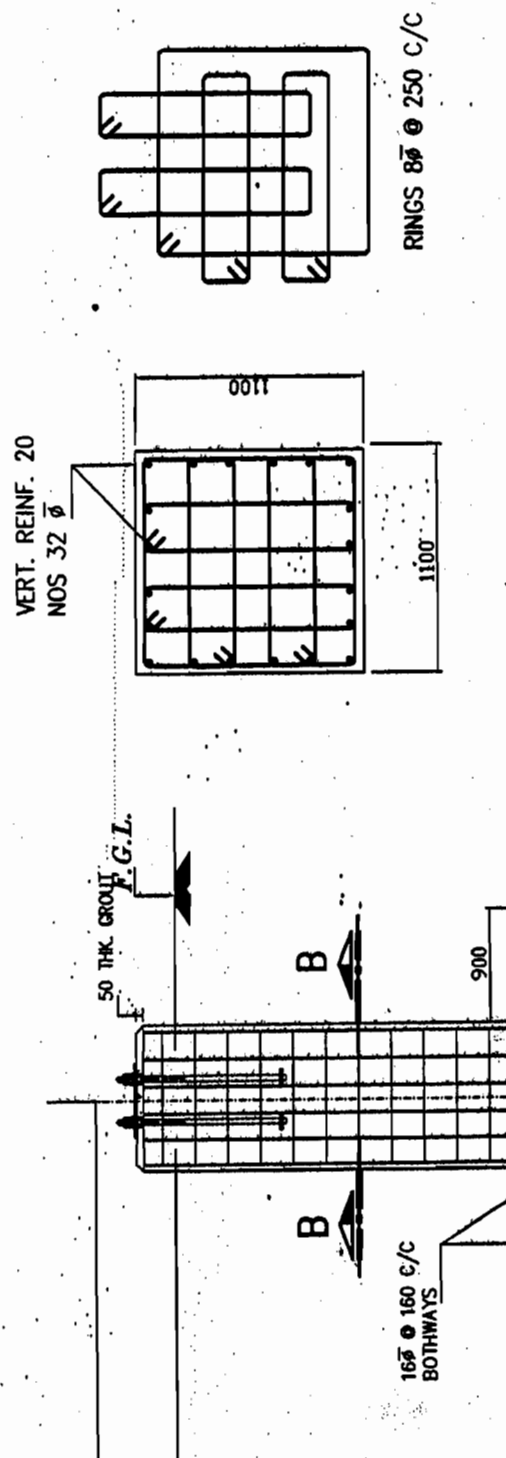

General Notes

1. FOR DETAILS OF FDN. BOLTS REFER APPROVED STRUCTURE DRAWING.
2. IN THIS DRAWING: Φ DENOTES REINF. STEEL CONFORMING TO I.S.1786 - 1985 OF GRADE Fe 500
3. LAP LENGTH SHALL BE 47 TIMES DIA OF BAR.
4. PROVIDE CLEAR COVER TO REINF. AS UNDER.
 - * 50mm FOR BOTTOM, TOP & SIDE REINFORCEMENT OF RAFT.
 - * 50mm FOR COLUMN.
5. ALL DIMENSIONS ARE IN MM UNLESS OTHERWISE NOTED
6. DO NOT SCALE THE DRAWING. ONLY WRITTEN DIMENSIONS SHALL BE FOLLOWED.
7. UNLESS OTHERWISE NOTED ALL CONCRETE SHALL BE OF GRADE M-25
8. FOR ORIENTATION OF FOUNDATION REFER APPROVED FDN. LAYOUT
9. FINAL EXCAVATION LEVEL SHALL BE MIN. 1000mm BELOW NGL.
10. IF EXPANSIVE SOIL IS ENCOUNTERED AT FOUNDING LVL. NECESSARY TREATMENT OF SOIL SHALL BE DONE AS PER RECOMMENDATIONS OF SOIL REPORT BEFORE PLACING THE FOUNDATION.
11. THIS DRAWING IS APPLICABLE FOR SBC OF 10T/Sq.M OR ABOVE

IMP:- LOCATION OF FDN. BOLTS SHALL BE VERIFIED FROM APPROVED STR. DRAWING BEFORE EMBEDDMENT

No.	Revision/Issue	Date
1.	RO	26/12/2011

POWER GRID CORPORATION

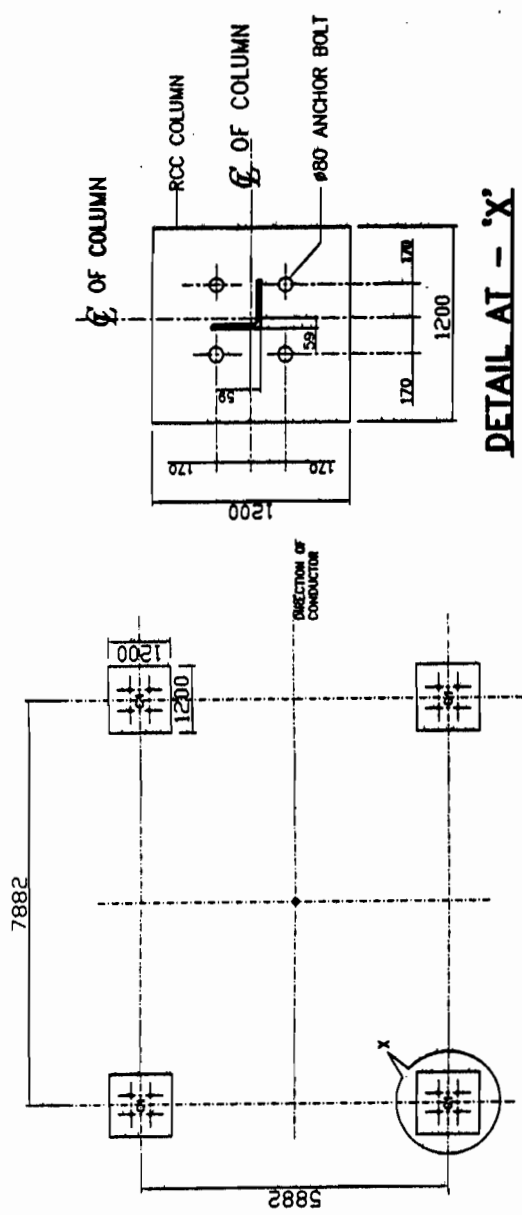

DETAIL AT - 'X'

TYP. ANCHOR BOLT SETTING PLAN FOR TOWER

VERT. REINF. 24 NOS 32 Φ

50 THK. GROUT F.G.L.

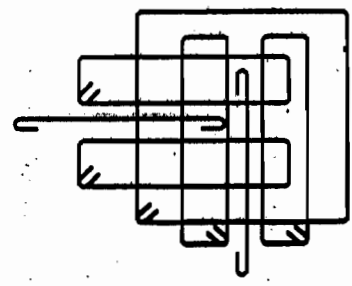
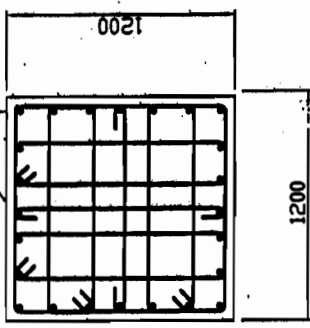

RINGS 8 Φ @ 250 C/C

16 Φ @ 150C/C BOTHWAYS

900

General Notes

1. FOR DETAILS OF FDN. BOLTS REFER APPROVED STRUCTURE DRAWING.
2. IN THIS DRAWING: ϕ DENOTES REINF. STEEL CONFORMING TO I.S.1786 - 1985 OF GRADE Fe 500
3. LAP LENGTH SHALL BE 47 TIMES DIA OF BAR.
4. PROVIDE CLEAR COVER TO REINF. AS UNDER.
* 50mm FOR BOTTOM, TOP & SIDE REINFORCEMENT OF RAFT.
* 50mm FOR COLUMN.
5. ALL DIMENSIONS ARE IN MM UNLESS OTHERWISE NOTED
6. DO NOT SCALE THE DRAWING. ONLY WRITTEN DIMENSIONS SHALL BE FOLLOWED.
7. UNLESS OTHERWISE NOTED ALL CONCRETE SHALL BE OF GRADE M-25
8. FOR ORIENTATION OF FOUNDATION REFER APPROVED FDN. LAYOUT
9. FINAL EXCAVATION LEVEL SHALL BE MIN. 1000mm BELOW NGL.
10. IF EXPANSIVE SOIL IS ENCOUNTERED AT FOUNDING LVL. NECESSARY TREATMENT OF SOIL SHALL BE DONE AS PER RECOMMENDATIONS OF SOIL REPORT BEFORE PLACING THE FOUNDATION.
11. THIS DRAWING IS APPLICABLE FOR SBC OF 10T/Sq.M OR ABOVE

IMP: - LOCATION OF FDN. BOLTS SHALL BE VERIFIED FROM APPROVED STR. DRAWING BEFORE EMBEDDMENT

1.	RO	26/12/2011
No.	Revision/Issue	Date

POWER GRID CORPORATION OF INDIA LIMITED

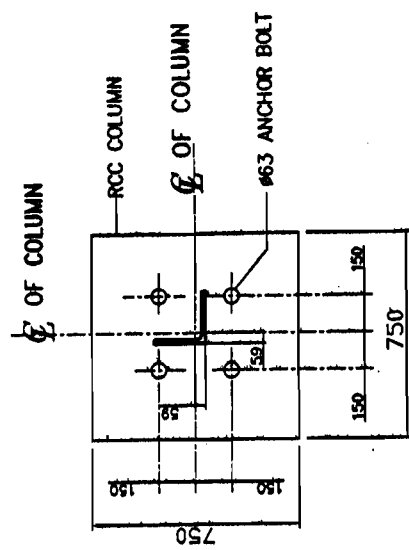
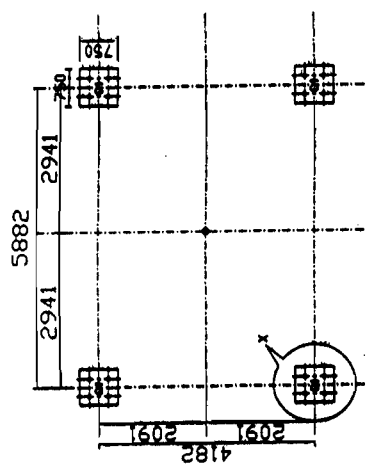

TOP ANCHOR BOLT SETTING PLAN FOR TOWER

DETAIL AT - 'X'

BHEL RELEASED FOR CONSTRUCTION PRINTS
 DESTROY EARLIER DATE 28/5/12
 SIGNED: *[Signature]*
 Transmission Projects Engineering Management

VERT. REINF. 20 NOS 32 ϕ

50 THK. GROUP F.G.L.

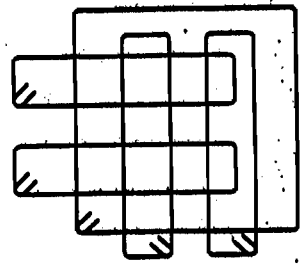
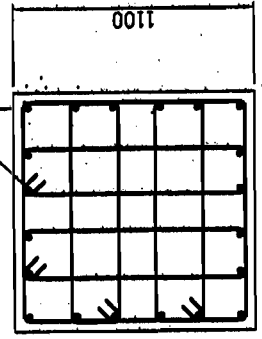

General Notes

1. FOR DETAILS OF FDN. BOLTS REFER APPROVED STRUCTURE DRAWING.
2. IN THIS DRAWING: ϕ DENOTES REINF. STEEL CONFORMING TO I.S.1786 - 1985 OF GRADE Fe 500
3. LAP LENGTH SHALL BE 47 TIMES DIA OF BAR.
4. PROVIDE CLEAR COVER TO REINF. AS UNDER.
 * 50mm FOR BOTTOM, TOP & SIDE REINFORCEMENT OF RAFT.
 * 50mm FOR COLUMN.
5. ALL DIMENSIONS ARE IN MM UNLESS OTHERWISE NOTED
6. DO NOT SCALE THE DRAWING. ONLY WRITTEN DIMENSIONS SHALL BE FOLLOWED.
7. UNLESS OTHERWISE NOTED ALL CONCRETE SHALL BE OF GRADE M-25
8. FOR ORIENTATION OF FOUNDATION REFER APPROVED FDN. LAYOUT
9. FINAL EXCAVATION LEVEL SHALL BE MIN. 1000mm BELOW NGL.
10. IF EXPANSIVE SOIL IS ENCOUNTERED AT FOUNDING LVL. NECESSARY TREATMENT OF SOIL SHALL BE DONE AS PER RECOMMENDATIONS OF SOIL REPORT BEFORE PLACING THE FOUNDATION
11. THIS DRAWING IS APPLICABLE FOR SBC OF 10T/Sq.M OR ABOVE

IMP. - LOCATION OF FDN. BOLTS SHALL BE VERIFIED FROM APPROVED STR. DRAWING BEFORE EMBEDDMENT

No.	Revision/Issue	Date
1.	RO	26/12/2011

POWER GRID CORPORATION

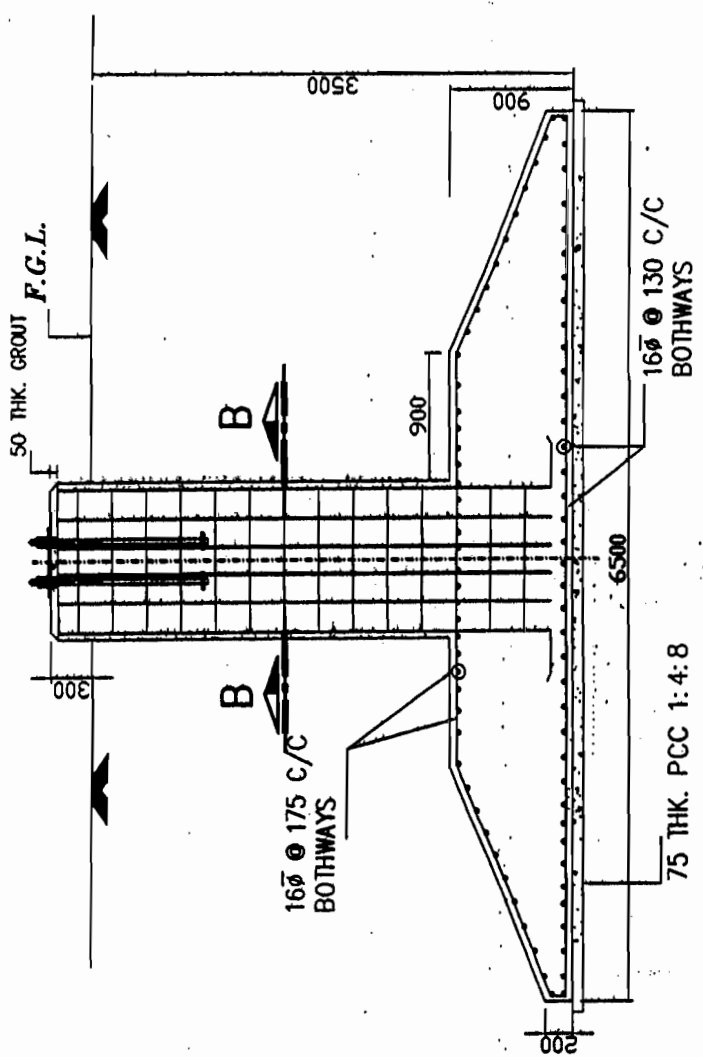

SECTION A-A

VERT. REINF. 20 NOS 32 ϕ

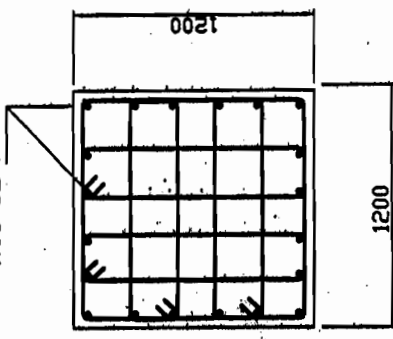

RINGS 8 ϕ @ 250 C/C

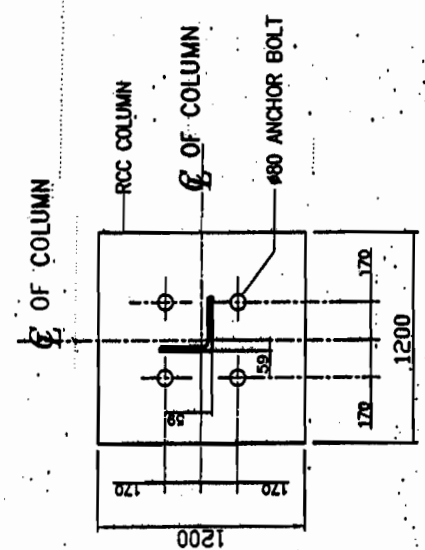
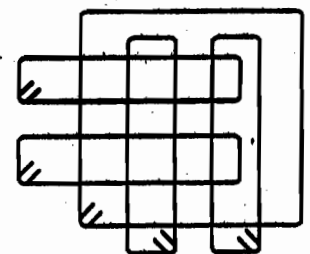

DIRECTION OF CONDUCTOR



S.No.	TOWER	L	B	d	D	(1)	(2)	(3)	e	N	X	Y	$\bar{\phi}$
1	TA	2800	2800	600	500	12 $\bar{\phi}$ @ 175 C/C	12 $\bar{\phi}$ @ 175 C/C	4-20 $\bar{\phi}$ + 12-16 $\bar{\phi}$	210	3	4638.2	4638.2	40
2	TB	4200	4200	600	600	16 $\bar{\phi}$ @ 150 C/C	16 $\bar{\phi}$ @ 225 C/C	4-28 $\bar{\phi}$ + 12-25 $\bar{\phi}$	320	3	4613.8	4613.8	56
3	TC	2600	2200	500	400	12 $\bar{\phi}$ @ 225 C/C	12 $\bar{\phi}$ @ 225 C/C	12-20 $\bar{\phi}$	210	3	4444.8	3444.8	28
4	TD	3750	3250	600	600	16 $\bar{\phi}$ @ 225 C/C	16 $\bar{\phi}$ @ 225 C/C	4-25 $\bar{\phi}$ + 12-20 $\bar{\phi}$	210	3	4416.8	3416.8	40
5	TE	3000	2200	500	450	12 $\bar{\phi}$ @ 200 C/C	12 $\bar{\phi}$ @ 175 C/C	4-16 $\bar{\phi}$ + 8-20 $\bar{\phi}$	210	3	4440	3440	40
6	TG	4200	3200	600	500	16 $\bar{\phi}$ @ 225 C/C	16 $\bar{\phi}$ @ 175 C/C	16-20 $\bar{\phi}$	210	3	4416.8	3416.8	40
7	TI	3500	2750	600	500	12 $\bar{\phi}$ @ 175 C/C	12 $\bar{\phi}$ @ 150 C/C	4-25 $\bar{\phi}$ + 8-20 $\bar{\phi}$	210	3	4428.2	3428.2	40
8	TK	3700	3700	600	500	16 $\bar{\phi}$ @ 175 C/C	16 $\bar{\phi}$ @ 250 C/C	4-25 $\bar{\phi}$ + 8-20 $\bar{\phi}$	210	3	4416.8	4416.8	40

VERT. REINF.(3)

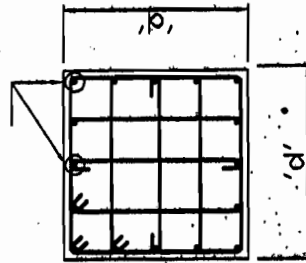

RINGS 8 $\bar{\phi}$ @ 250 C/C

SECTION B-B
(FOR 16 NOS VERT. BARS)

VERT. REINF.(3)

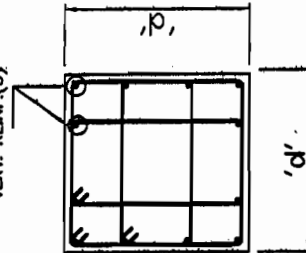

RINGS 8 $\bar{\phi}$ @ 250 C/C

SECTION B-B
(FOR 12 NOS VERT. BARS)

$\bar{\phi}$ OF COLUMN

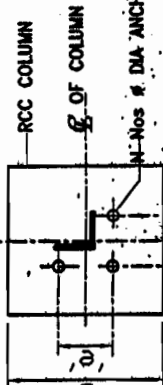

General Notes

- FOR DETAILS OF FDN. BOLTS REFER APPROVED STRUCTURE DRAWING.
- IN THIS DRAWING $\bar{\phi}$ DENOTES REINF. STEEL CONFORMING TO I.S.1786 - 1985 OF GRADE Fe 500
- LAP LENGTH SHALL BE 47 TIMES DIA OF BAR.
- PROVIDE CLEAR COVER TO REINF. AS UNDER.
* 50mm FOR BOTTOM, TOP & SIDE REINFORCEMENT OF RAFT.
* 50mm FOR COLUMN.
- ALL DIMENSIONS ARE IN MM UNLESS OTHERWISE NOTED.
- DO NOT SCALE THE DRAWING. ONLY WRITTEN DIMENSIONS SHALL BE FOLLOWED.
- UNLESS OTHERWISE NOTED ALL CONCRETE SHALL BE OF GRADE M-25
- FOR ORIENTATION OF FOUNDATION REFER APPROVED FDN. LAYOUT
- FINAL EXCAVATION LEVEL SHALL BE MIN. 1000mm BELOW NGL.
- INCREASE EXPANSIVE SOIL IS ENCOUNTERED AT FOUNDING LEVEL, NECESSARY TREATMENT OF SOIL SHALL BE DONE AS PER RECOMMENDATIONS OF SOIL REPORT BEFORE PLACING THE FOUNDATIONS
- THIS DRAWING IS APPLICABLE FOR A S.B.C. OF 9T/SQ.M OR ABOVE

IMP:- LOCATION OF FDN. BOLTS SHALL BE VERIFIED FROM APPROVED STR. DRAWING BEFORE EMBEDDMENT

1. RO 03/02/2012
No. Revision/Issue Date

POWER GRID CORPORATION OF INDIA LIMITED

BHEL RELEASED FOR CONSTRUCTION PRINTS
DESTROY EARLIER DATE 28/12/12
SIGNED: P. W. [Signature]
Transmission Projects Engineering Management

General Notes

1. FOR DETAILS OF FDN. BOLTS REFER APPROVED STRUCTURE DRAWING.
 2. IN THIS DRAWING: \varnothing DENOTES REINF. STEEL CONFORMING TO I.S.1786 - 1985 OF GRADE Fe 500
 3. LAP LENGTH SHALL BE 47 TIMES DIA OF BAR.
 4. PROVIDE CLEAR COVER TO REINF. AS UNDER.
* 50mm FOR BOTTOM, TOP & SIDE REINFORCEMENT OF RAFT.
* 50mm FOR COLUMN.
 5. ALL DIMENSIONS ARE IN MM UNLESS OTHERWISE NOTED
 6. DO NOT SCALE THE DRAWING. ONLY WRITTEN DIMENSIONS SHALL BE FOLLOWED.
 7. UNLESS OTHERWISE NOTED ALL CONCRETE SHALL BE OF GRADE M-25
 8. FOR ORIENTATION OF FOUNDATION REFER APPROVED FDN. LAYOUT
 9. FINAL EXCAVATION LEVEL SHALL BE MIN. 1000mm BELOW NGL.
 10. INCREASE EXPANSIVE SOIL IS ENCOUNTERED AT FOUNDING LEVEL, NECESSARY TREATMENT OF SOIL SHALL BE DONE AS PER RECOMMENDATIONS OF SOIL REPORT BEFORE PLACING THE FOUNDATIONS
- THIS DRAWING IS APPLICABLE FOR A S.B.C. OF 9T/SQ.M OR ABOVE

IMP:-- LOCATION OF FDN. BOLTS SHALL BE VERIFIED FROM APPROVED STR. DRAWING BEFORE EMBEDDMENT

1	RO	03/02/2012
No.	Revision/Issue	Date
POWER GRID CORPORATION		

S.No.	TOWER	L	B	d	D	(1)	(2)	(3)	e	N	X	Y	$\bar{\varnothing}$
1	TF	8000	7000	600	600	16 $\bar{\varnothing}$ @ 200 C/C	12 $\bar{\varnothing}$ @ 150 C/C	12-25 $\bar{\varnothing}$	320	3	4413.8	3413.8	56
2	TH	9500	8500	600	700	20 $\bar{\varnothing}$ @ 175 C/C	16 $\bar{\varnothing}$ @ 190 C/C	4-28 $\bar{\varnothing}$ + 12-25 $\bar{\varnothing}$	320	4	4385.8	3385.8	56
3	TJ	9000	8000	600	600	20 $\bar{\varnothing}$ @ 190 C/C	16 $\bar{\varnothing}$ @ 190 C/C	16-25 $\bar{\varnothing}$	320	4	4388.8	3388.8	56
4	TL	9200	9200	600	750	20 $\bar{\varnothing}$ @ 175 C/C	16 $\bar{\varnothing}$ @ 220 C/C	4-28 $\bar{\varnothing}$ + 12-25 $\bar{\varnothing}$	320	4	4385.8	4385.8	56
5	TM	8200	8200	600	600	16 $\bar{\varnothing}$ @ 140 C/C	12 $\bar{\varnothing}$ @ 150 C/C	12-25 $\bar{\varnothing}$	320	3	4410.8	4410.8	56
6	TN	8600	8600	600	650	16 $\bar{\varnothing}$ @ 125 C/C	16 $\bar{\varnothing}$ @ 250 C/C	4-28 $\bar{\varnothing}$ + 12-25 $\bar{\varnothing}$	320	4	4388.8	4388.8	56

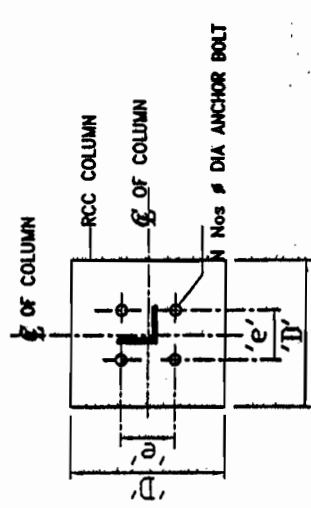

DETAIL AT - 'X'
(FOR 4 NOS BOLTS)

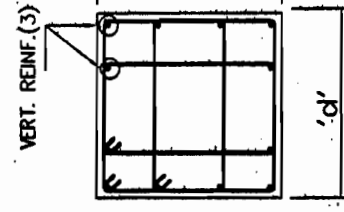

SECTION B-B
(FOR 12 NOS VERT. BARS)

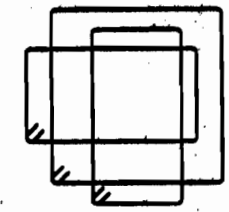

RINGS: 8# @ 250 C/C

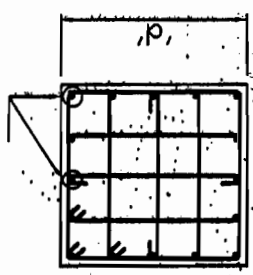

VERT. REINF. (3)

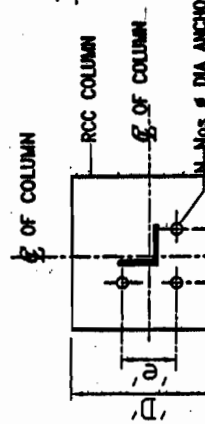
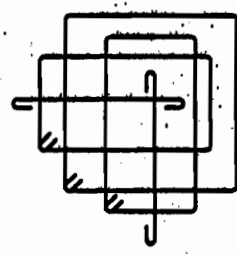

S.No.	TOWER	L	B	d	D	(1)	(2)	(3)	e	N	X	Y	$\bar{\phi}$
1	TP	8200	7200	750	600	16 $\bar{\phi}$ @ 250 C/C	16 $\bar{\phi}$ @ 250 C/C	16-28 $\bar{\phi}$	320	4	4385.8	3385.8	56
2	TQ	9600	8600	750	750	20 $\bar{\phi}$ @ 175 C/C	16 $\bar{\phi}$ @ 200 C/C	8-32 $\bar{\phi}$ + 12-28 $\bar{\phi}$	320	4	4385.8	3385.8	56
3	TR	8200	7200	750	600	16 $\bar{\phi}$ @ 250 C/C	16 $\bar{\phi}$ @ 250 C/C	16-28 $\bar{\phi}$	320	4	4385.8	3385.8	56
4	TS	9600	8600	750	750	20 $\bar{\phi}$ @ 175 C/C	16 $\bar{\phi}$ @ 200 C/C	8-32 $\bar{\phi}$ + 12-28 $\bar{\phi}$	320	4	4385.8	3385.8	56
5	TW	8700	7700	750	600	16 $\bar{\phi}$ @ 150 C/C	16 $\bar{\phi}$ @ 225 C/C	20-25 $\bar{\phi}$	320	4	4385.8	3385.8	56

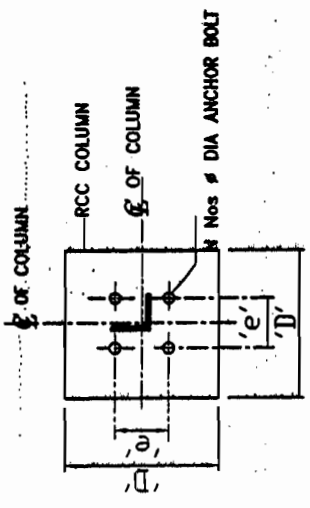

DETAIL AT - 'X'

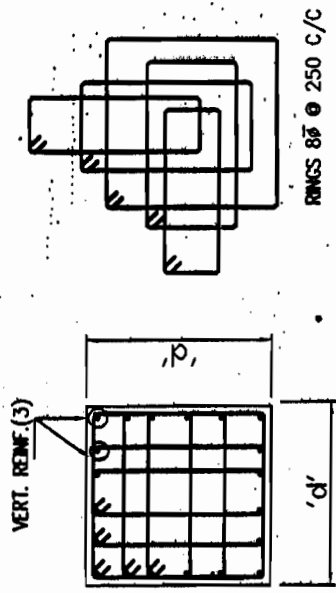

SECTION B-B
(FOR 20 NOS VERT. BARS)

VERT. REINF.(3)

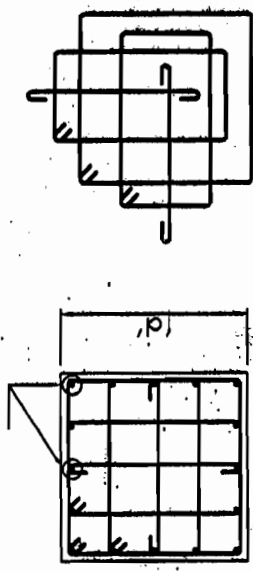

General Notes

- FOR DETAILS OF FDN. BOLTS REFER APPROVED STRUCTURE DRAWING.
- IN THIS DRAWING: $\bar{\phi}$ DENOTES REINF. STEEL CONFORMING TO I.S.1786 - 1985 OF GRADE Fe 500
- LAP LENGTH SHALL BE 47 TIMES DIA OF BAR.
- PROVIDE CLEAR COVER TO REINF. AS UNDER.
* 50mm FOR BOTTOM, TOP & SIDE REINFORCEMENT OF RAFT.
* 50mm FOR COLUMN.
- ALL DIMENSIONS ARE IN MM UNLESS OTHERWISE NOTED.
- DO NOT SCALE THE DRAWING. ONLY WRITTEN DIMENSIONS SHALL BE FOLLOWED.
- UNLESS OTHERWISE NOTED ALL CONCRETE SHALL BE OF GRADE M-25
- FOR ORIENTATION OF FOUNDATION REFER APPROVED FDN. LAYOUT
- FINAL EXCAVATION LEVEL SHALL BE MIN. 1000mm BELOW NGL.
- INCREASE EXPANSIVE SOIL IS ENCOUNTERED AT FOUNDING LEVEL, NECESSARY TREATMENT OF SOIL SHALL BE DONE AS PER RECOMMENDATIONS OF SOIL REPORT BEFORE PLACING THE FOUNDATIONS

THIS DRAWING IS APPLICABLE FOR A S.B.C. OF 10T/SQ.M OR ABOVE

IMP: - LOCATION OF FDN. BOLTS SHALL BE VERIFIED FROM APPROVED STR. DRAWING BEFORE EMBEDDMENT

No.	Revision/Issue	Date
1.	R0	03/02/2012

POWER GRID CORPORATION OF INDIA LIMITED

BHEL RELEASED FOR CONSTRUCTION PRINTS DESTROY EARLIER PRINTS SIGNED: [Signature] DATE: 23/5/12
Transmission Projects Engineering Management

S.No.	TOWER	L	B	d	D	(1)	(2)	(3)	e	N	X	Y	$\bar{\phi}$
1	TT	4300	5600	900	900	20 ϕ @ 150 C/C	16 ϕ @ 175 C/C	4-32 ϕ + 16-28 ϕ	320	4	4382.0	5882.0	56
2	TU	4250	4750	900	750	16 ϕ @ 175 C/C	16 ϕ @ 220 C/C	20-28 ϕ	320	4	4382.0	5882.0	56
3	TV	5000	5000	900	750	16 ϕ @ 140 C/C	16 ϕ @ 220 C/C	8-28 ϕ + 12-32 ϕ	320	4	5882.0	5882.0	56
4	TX	4300	5300	1200	900	20 ϕ @ 150 C/C	16 ϕ @ 175 C/C	12-25 ϕ + 8-28 ϕ	320	4	4382.0	5882.0	56
5	TY	4800	4000	900	750	16 ϕ @ 220 C/C	16 ϕ @ 220 C/C	12-25 ϕ + 8-28 ϕ	320	4	5885.8	4385.8	56
6	TZ	4000	4750	900	900	16 ϕ @ 150 C/C	16 ϕ @ 175 C/C	8-25 ϕ + 12-28 ϕ	320	4	4385.8	5885.8	56

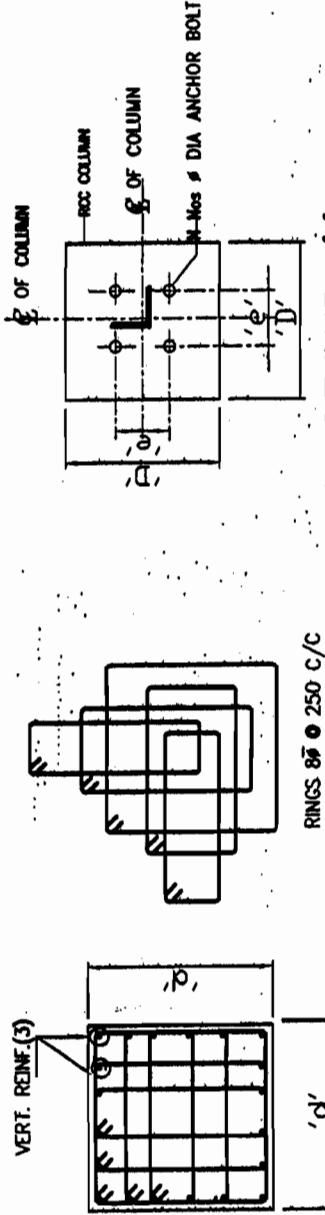

SECTION B-B
(FOR 20 NOS. VERT. BARS)

DETAIL AT 'X'
(FOR 4 NOS BOLTS)

General Notes

- FOR DETAILS OF FDN. BOLTS REFER APPROVED STRUCTURE DRAWING.
- IN THIS DRAWING: ϕ DENOTES REINF. STEEL CONFORMING TO I.S.1786 - 1985 OF GRADE Fe 500
- LAP LENGTH SHALL BE 47 TIMES DIA OF BAR.
- PROVIDE CLEAR COVER TO REINF. AS UNDER.
* 50mm FOR BOTTOM, TOP & SIDE REINFORCEMENT OF RAFT.
* 50mm FOR COLUMN.
- ALL DIMENSIONS ARE IN MM UNLESS OTHERWISE NOTED
- DO NOT SCALE THE DRAWING. ONLY WRITTEN DIMENSIONS SHALL BE FOLLOWED.
- UNLESS OTHERWISE NOTED ALL CONCRETE SHALL BE OF GRADE M-25
- FOR ORIENTATION OF FOUNDATION REFER APPROVED FDN. LAYOUT
- FINAL EXCAVATION LEVEL SHALL BE MIN. 1000mm BELOW NGL.
- IN CASE EXPANSIVE SOIL IS ENCOUNTERED AT FOUNDING LEVEL, NECESSARY TREATMENT OF SOIL SHALL BE DONE AS PER RECOMMENDATIONS OF SOIL REPORT BEFORE PLACING THE FOUNDATIONS

THIS DRAWING IS APPLICABLE FOR A S.B.C. OF 10T/SQ.M OR ABOVE

IMP:- LOCATION OF FDN. BOLTS SHALL BE VERIFIED FROM APPROVED STR. DRAWING BEFORE EMBEDDMENT

1.	RO	03/02/2012
No.	Revision/Issue	Date
POWER GRID CORPORATION		

BHEL RELEASED
FOR CONSTRUCTION PRINTS
 DESTROY EARLIER DATE 20/5/10
 SIGNED: [Signature] DATE 20/5/10
 Transmission Projects
 Engineering Management

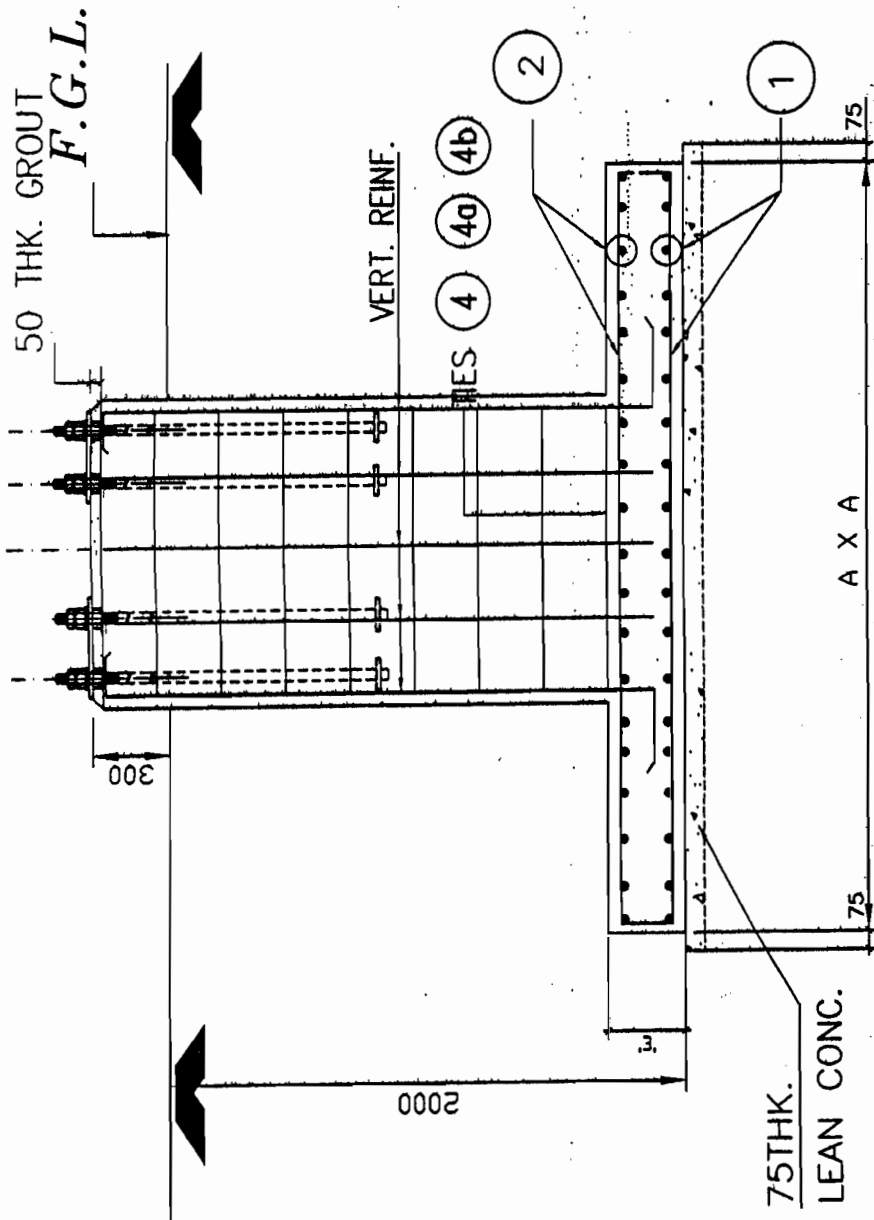

BHEL RELEASED
 FOR
CONSTRUCTION
DESTROY EARLIER PRINTS
 SIGNED *[Signature]* DATE 23/5/12
 Transmission Projects
 Engineering Management

General Notes

1. FOR DETAILS OF FDN. BOLTS REFER APPROVED STRUCTURE DRAWING.
2. IN THIS DRAWING: ϕ DENOTES REINF. STEEL CONFORMING TO I.S.1786 - 1985 OF GRADE Fe 500
3. LAP LENGTH SHALL BE 47 TIMES DIA OF BAR.
4. PROVIDE CLEAR COVER TO REINF. AS UNDER.
 * 50mm FOR BOTTOM, TOP & SIDE REINFORCEMENT OF RAFT.
 * 50mm FOR COLUMN.
5. ALL DIMENSIONS ARE IN MM UNLESS OTHERWISE NOTED
6. DO NOT SCALE THE DRAWING. ONLY WRITTEN DIMENSIONS SHALL BE FOLLOWED.
7. UNLESS OTHERWISE NOTED ALL CONCRETE SHALL BE OF GRADE M-25
8. FOR ORIENTATION OF FOUNDATION REFER APPROVED FDN. LAYOUT
9. FINAL EXCAVATION LEVEL SHALL BE MIN. 500mm BELOW NGL.
10. IF EXPANSIVE SOIL IS ENCOUNTERED AT FOUNDING LVL. NECESSARY TREATMENT OF SOIL SHALL BE DONE AS PER RECOMMENDATIONS OF SOIL REPORT BEFORE PLACING THE FOUNDATIONS.
11. THIS DRAWING IS APPLICABLE FOR S.B.C. OF 8T/Sqm OR ABOVE

IMP: - LOCATION OF FDN. BOLTS SHALL BE VERIFIED FROM APPROVED SUPP. STR. DRAWING BEFORE EMBEDDMENT

No.	Revision/Issue	Date
1.	RO	24/01/2012

EQUIPMENT MARKED :-

ISO	CT	CVT	BPI
3150 X 3150	3650 X 3650	3150 X 3150	3050 X 3050
4000 X 3000	3500 X 3500	3000 X 3000	2900 X 2900
1200 X 1200	1200 X 1200	1000 X 1000	1200 X 1200
698.2 X 698.2	691.6 X 691.6	543.2 X 543.2	699.8 X 699.8
750 X 750	750 X 750	600 X 600	750 X 750
375	375	375	375
375	375	375	375
20	20	20	20
255 X 255	255 X 255	255 X 255	255 X 255
3	3	3	3
32	32	32	32
300	400	300	300
443.2 X 443.2	436.6 X 436.6	288.2 X 288.2	444.8 X 444.8
953.2 X 953.2	946.6 X 946.6	798.2 X 798.2	954.8 X 954.8
200 C/C	12 200 C/C	12 200 C/C	12 200 C/C
250 C/C	12 225 C/C	12 250 C/C	12 250 C/C
4-16 20	4-16 20	16-12 20	4-16 20
12-12 20	12-12 20	-	12-12 20
8 190 C/C	8 190 C/C	8 190 C/C	8 190 C/C
8 190 C/C	8 190 C/C	8 190 C/C	8 190 C/C
8 190 C/C	8 190 C/C	8 190 C/C	8 190 C/C

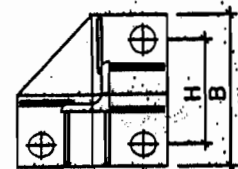
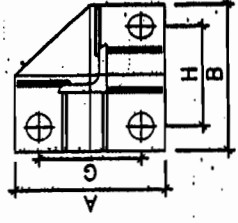
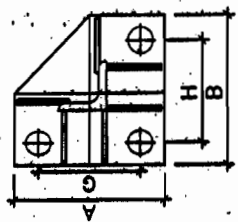
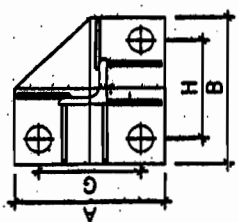
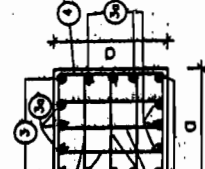
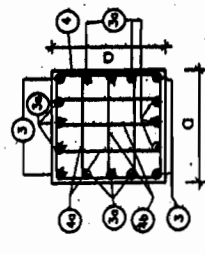
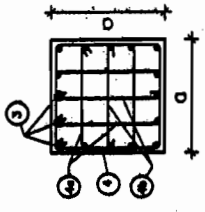
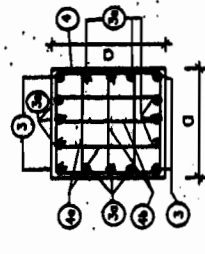

General Notes

- FOR DETAILS OF FDN. BOLTS REFER APPROVED STRUCTURE DRAWING.
- IN THIS DRAWING: Φ DENOTES REINF. STEEL CONFORMING TO I.S.1786 - 1985 OF GRADE Fe 500 OR EQUIVALENT GRADE TMT BARS
- LAP LENGTH SHALL BE 47 TIMES DIA OF BAR.
- PROVIDE CLEAR COVER TO REINF. AS UNDER.
 - * 50mm FOR BOTTOM, TOP & SIDE REINFORCEMENT OF RAFT.
 - * 50mm FOR COLUMN.
- ALL DIMENSIONS ARE IN MM UNLESS OTHERWISE NOTED
- DO NOT SCALE THE DRAWING. ONLY WRITTEN DIMENSIONS SHALL BE FOLLOWED.
- UNLESS OTHERWISE NOTED ALL CONCRETE SHALL BE OF GRADE M-25
- FOR ORIENTATION OF FOUNDATION REFER APPROVED FDN. LAYOUT
- FINAL EXCAVATION LEVEL SHALL BE MIN. 500mm BELOW NGL
- IF EXPANSIVE SOIL IS ENCOUNTERED AT FOUNDING LVL. NECESSARY TREATMENT OF SOIL SHALL BE DONE AS PER RECOMMENDATIONS OF SOIL REPORT BEFORE PLACING THE FOUNDATIONS.
- THIS DRAWING IS APPLICABLE FOR S.B.C. OF 8T/Sqm OR ABOVE

IMP:- LOCATION OF FDN. BOLTS SHALL BE VERIFIED FROM APPROVED SUPP. STR. DRAWING BEFORE EMBEDDMENT

1.	RO	24/01/2012
No	Revision/Issue	Date

General Notes

1. FOR DETAILS OF FDN. BOLTS REFER APPROVED STRUCTURE DRAWING.
2. IN THIS DRAWING: ϕ DENOTES REINF. STEEL CONFORMING TO I.S.1786 - 1985 OF GRADE Fe 500
3. LAP LENGTH SHALL BE 47 TIMES DIA OF BAR.
4. PROVIDE CLEAR COVER TO REINF. AS UNDER:
 * 50mm FOR BOTTOM, TOP & SIDE REINFORCEMENT OF RAFT.
 * 50mm FOR COLUMN.
5. ALL DIMENSIONS ARE IN MM UNLESS OTHERWISE NOTED
6. DO NOT SCALE THE DRAWING. ONLY WRITTEN DIMENSIONS SHALL BE FOLLOWED.
7. UNLESS OTHERWISE NOTED ALL CONCRETE SHALL BE OF GRADE M-25
8. FOR ORIENTATION OF FOUNDATION REFER APPROVED FDN. LAYOUT
9. FINAL EXCAVATION LEVEL SHALL BE MIN. 500mm BELOW NGL.
10. IF EXPANSIVE SOIL IS ENCOUNTERED AT FOUNDING LVL. NECESSARY TREATMENT TO SOIL SHALL BE DONE AS PER SOIL REPORT RECOMMENDATIONS BEFORE PLACING THE FOUNDATIONS

IMP:- LOCATION OF FDN. BOLTS SHALL BE VERIFIED FROM APPROVED SUPP. STR. DRAWING BEFORE EMBEDDMENT

No.	Revision/Issue	Date
1.	RO	02/02/2012

POWER GRID CORPORATION OF INDIA LIMITED

BHEL RELEASED FOR CONSTRUCTION PRINTS DESTROY EARLIER DATE 23/11/2011
 SIGNED: [Signature] Transmission Projects Engineering Management

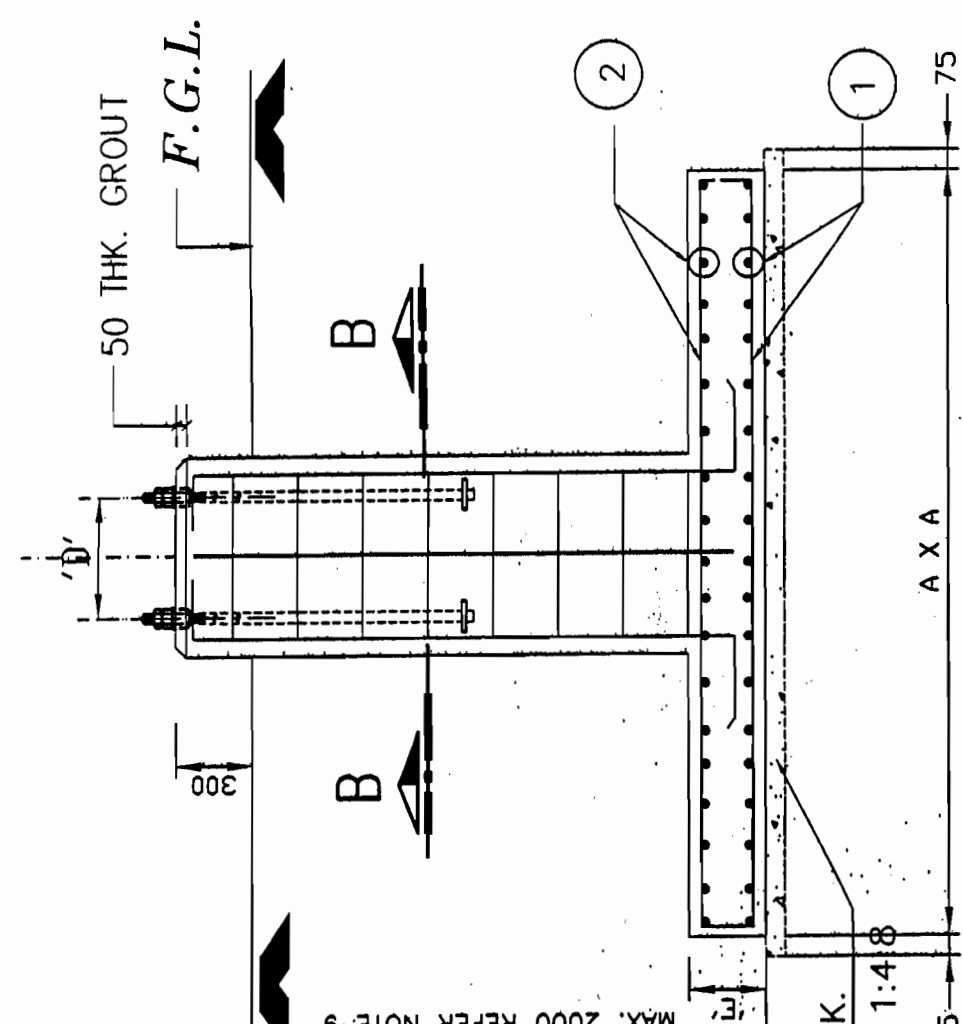

SECTION A-A

(1)	(2)	(3)	'D'	'd'
ϕ 10 C/C	10 ϕ e 250 C/C	8-12 ϕ	340	28
ϕ 10 C/C	10 ϕ e 250 C/C	8-12 ϕ	375	28
ϕ 10 C/C	10 ϕ e	4-16 ϕ	150	28

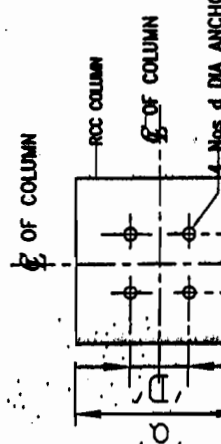

MAX. 2000 REFER NOTE 9

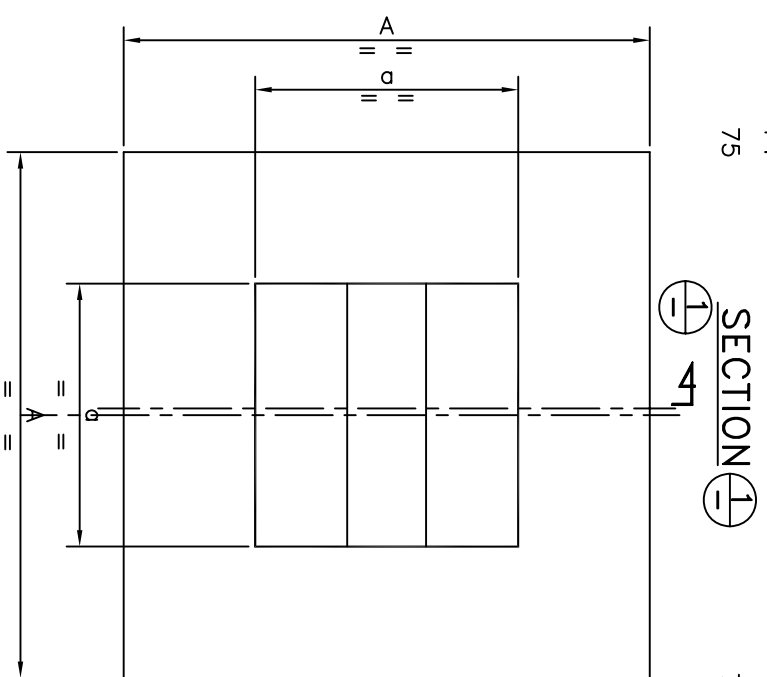
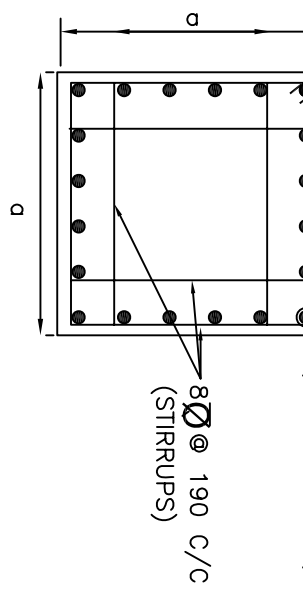
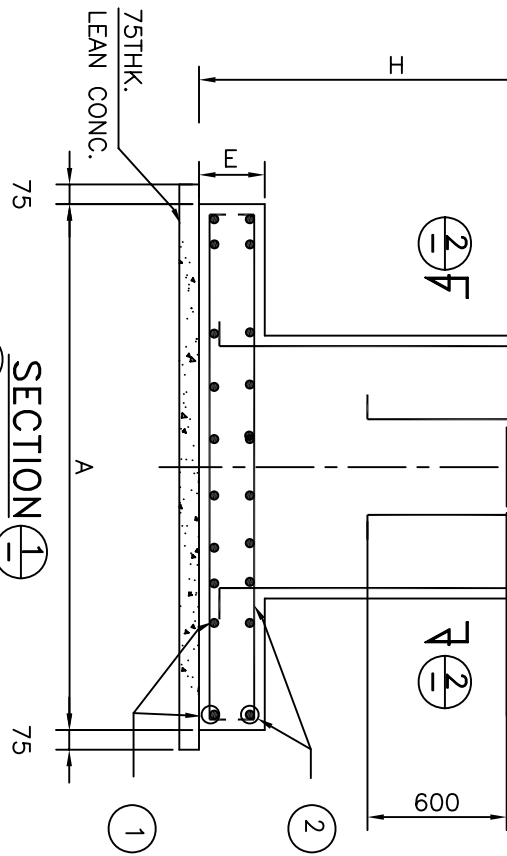

PEDASTAL SIZES FOR VARIOUS MAKES OF CB

VOLTAGE	MAKE	d
400 KV	CGI	1200
	ABB	1600
220 KV	CGI	1000
	ABB	1600

FOUNDATION PLAN OF CIRCUIT BREAKER

APPROVED BY ED (ENGG) ON 02.05.2005 VIDE NOTE
 SHEET REF. NO. C/ENGG./CV/STD-S/S DTD 30.03.2005

ACDE(ENGG- CIVIL)	CDE(ENGG- CIVIL)	DGM(ENGG- CIVIL)	AGM(ENGG- TL/CIVIL)	GM(ENGG-S/S)	GM(ENGG- TL/CIVIL)	ED(ENGG)

